

Total solder points: 18

Difficulty level: *beginner* 1 2 3 4 5 *advanced*

UNIVERSAL POWER SUPPLY 5 - 14DC / 1A

K2570

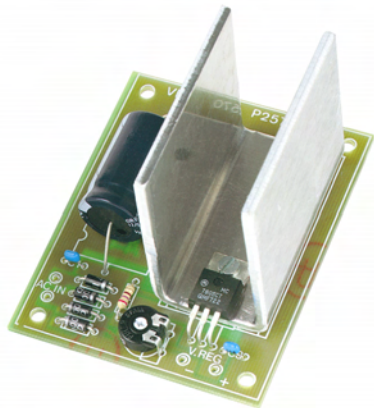

The easy way to power your projects.

Features

Suits all Velleman kits requiring a regulated power supply between 5 and 12VDC, and no more than 1A.

Specifications :

- Input voltage: 7-16VDC / 1A
- Output voltage: 5-14VDC, regulated
- Output current: max. 1A
- Power limitation and thermal overload protection
- Max. dissipation: 7W
- PCB dimensions: 77 x 61mm (3.0" x 2.4")

Can be combined with :

K1771	FM - oscillator	K2656	Universal crystal timebase
K1803	Universal mono pre - amplifier	K3400	Dual electronic dice
K2032	Digital panel meter	K4601	Audio / video tv modulator
K2572	Universal stereo pre-amplifier	K4900	Telephone amplifier
K2573	Stereo RIAA pre - amplifier	K6400	Code lock
K2579	Universal start / stop timer	K8015	Multifunction relay switch
K2651	LCD panel meter	VM114	7W mono audio amplifier
K2655	Electronic watchdog		

1. Assembly (Skipping this can lead to troubles !)

Ok, so we have your attention. These hints will help you to make this project successful. Read them carefully.

1.1 Make sure you have the right tools:

- A good quality soldering iron (25-40W) with a small tip.
- Wipe it often on a wet sponge or cloth, to keep it clean; then apply solder to the tip, to give it a wet look. This is called 'thinning' and will protect the tip, and enables you to make good connections. When solder rolls off the tip, it needs cleaning.
- Thin rosin-core solder. Do not use any flux or grease.
- A diagonal cutter to trim excess wires. To avoid injury when cutting excess leads, hold the lead so they cannot fly towards the eyes.
- Needle nose pliers, for bending leads, or to hold components in place.
- Small blade and Phillips screwdrivers. A basic range is fine.

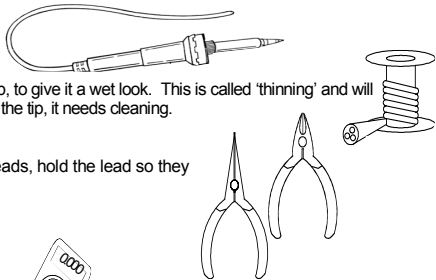

For some projects, a basic multi-meter is required, or might be handy

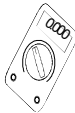
**1.2 Assembly Hints :**

- ⇒ Make sure the skill level matches your experience, to avoid disappointments.
 - ⇒ Follow the instructions carefully. Read and understand the entire step before you perform each operation.
 - ⇒ Perform the assembly in the correct order as stated in this manual
 - ⇒ Position all parts on the PCB (Printed Circuit Board) as shown on the drawings.
 - ⇒ Values on the circuit diagram are subject to changes.
 - ⇒ Values in this assembly guide are correct*
 - ⇒ Use the check-boxes to mark your progress.
 - ⇒ Please read the included information on safety and customer service
- * Typographical inaccuracies excluded. Always look for possible last minute manual updates, indicated as 'NOTE' on a separate leaflet.

1.3 Soldering Hints :

1- Mount the component against the PCB surface and carefully solder the leads

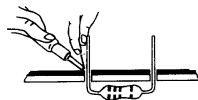

2- Make sure the solder joints are cone-shaped and shiny

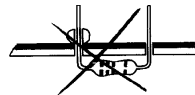
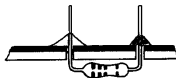

3- Trim excess leads as close as possible to the solder joint

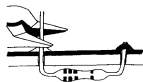

REMOVE THEM FROM THE TAPE ONE AT A TIME !

DO NOT BLINDLY FOLLOW THE ORDER OF THE COMPONENTS ONTO THE TAPE. ALWAYS CHECK THEIR VALUE ON THE PARTS LIST!

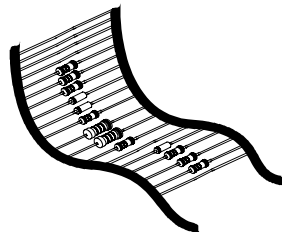

1. Diodes. Watch the polarity !

- D1 : 1N4007
- D2 : 1N4007
- D3 : 1N4007
- D4 : 1N4007

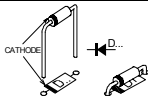

2. Resistor

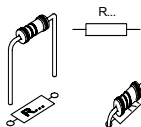

- R1 : 270 (2 - 7 - 1 - B)

3. Capacitors

- C1 : 100nF (104)
- C3 : 100nF (104)

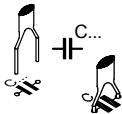

4. Trim potentiometer

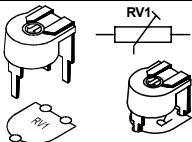

- RV1 : 470 ohm

5. Electrolytic Capacitor. Watch the polarity !

- C2 : 2200 μ F

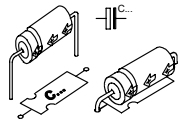

6. Voltage regulator

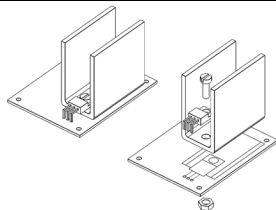

- VR : UA7805

- Place the heatsink and the regulator on the PCB.
- ☞ Ensure that the hole of the heatsink and the one of the regulator correspond to the hole in the PCB.
- ☞ Use heatsink compound to ensure good heat dissipation.
- Fix the two components with an M3 bolt and nut.
- Now, the regulator may be soldered.

7. Use

To use the circuit without problem, take into account the power dissipation in the regulator.

☞ The transformer voltage must always be 2V higher than the maximum desired output voltage.

If, for instance, you need an output voltage of 12V, then you need to fit a transformer of 14V.

If, as an output voltage you only need 6V, use a transformer having 8V and not 14V, because with an 8V transformer the dissipation in the regulator will be of approximately 5W when drawing a current of 1A. With a 14V transformer, the dissipation will be higher than 10W. In the second case the regulator will die in a few minutes.

The transformer should be connected to the points "AC IN" and the output voltage is connected at points + and - (Vreg).

8. PCB

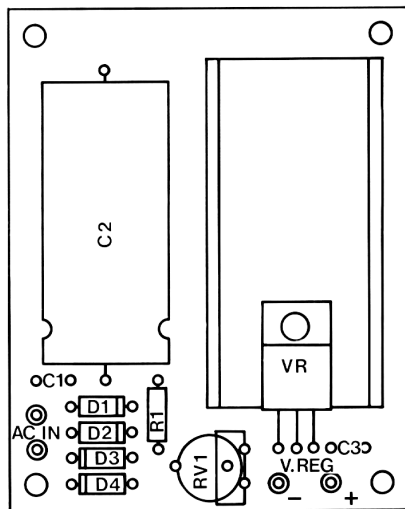

9. DIAGRAM

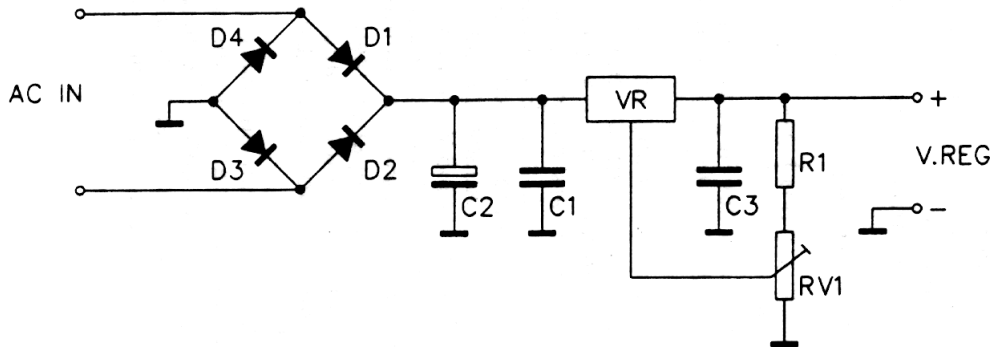

VELBUS
Velleman Home Automation System

VELBUS
Velleman Home Automation System

**All appliances get intelligent, how about your home?
see our website : www.velbus.be**

Modifications and typographical errors reserved
© Velleman nv.
H2570IP - 2004 - ED1 (rev.1.0)

VELLEMAN NV
Legen Heirweg 33, 9890 Gavere
Belgium - Europe

