

Total solder points: 74

Difficulty level: *beginner* 1  2  3  4  5  *advanced*

## BUS DIMMER FOR HOME MODULAR LIGHT SYSTEM

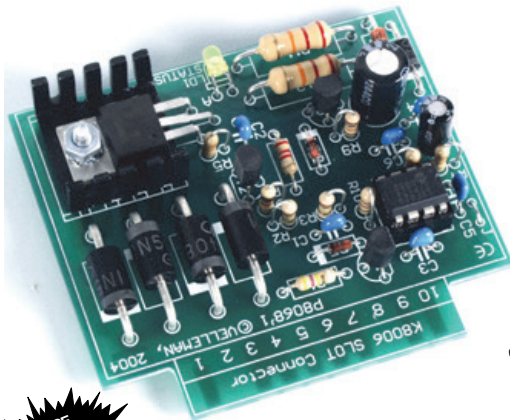

# K8068

“PLUG - IN” module for use with home modular lights system K8006.

**For electronic transformers!**

**NOISE  
SUPPRESSED  
ACCORDING TO  
EN55015**

This dimmer is a plug-in module for our K8006 home modular light system suitable for incandescent lamps, and halogen lighting. This dimmer uses phase control technology. The main advantages of this technology are a reduced harmonic distortion on the mains and the fact that this dimmer can be used for electronic transformer, used in low voltage halogen lighting.

### Specifications:

- ☑ PLUG-IN' module for use with our home modular light system K8006 only.
- ☑ Suitable for incandescent lamps, mains voltage halogen lighting and low voltage halogen lighting in combination with an electronic transformer.
- ☑ Inductor- and filter free, reverse phase control technology with coolMOS™ FET-transistor.
- ☑ A brief push toggles on/off, while continued pushing engages dimming action
- ☑ "Soft-start" safety feature to make lamps last as long as possible.
- ☑ Non volatile memory for last set light intensity.
- ☑ Reduced harmonic distortion (less EMI), according to EN55015.
- ☑ LED status indication.

### Features:

- Operating voltages: 110-125V or 220-240V AC (50/60Hz)
- Max. load: 300W/230V or 150W/115V, 0-98% adjustable.
- dimming cycle speed: +/- 5 sec.
- PCB dimensions: 65 x 57 x 20mm.



**☞ It is not recommended to use this dimmer with wire-wound transformers.**

## 1. Assembly (Skipping this can lead to troubles !)

Ok, so we have your attention. These hints will help you to make this project successful. Read them carefully.

### 1.1 Make sure you have the right tools:

- A good quality soldering iron (25-40W) with a small tip.
- Wipe it often on a wet sponge or cloth, to keep it clean; then apply solder to the tip, to give it a wet look. This is called 'tinning' and will protect the tip, and enables you to make good connections. When solder rolls off the tip, it needs cleaning.
- Thin rosin-core solder. Do not use any flux or grease.
- A diagonal cutter to trim excess wires. To avoid injury when cutting excess leads, hold the lead so they cannot fly towards the eyes.
- Needle nose pliers, for bending leads, or to hold components in place.
- Small blade and Phillips screwdrivers. A basic range is fine.

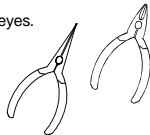

For some projects, a basic multi-meter is required, or might be handy

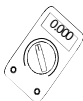

### 1.2 Assembly Hints :

- ⇒ Make sure the skill level matches your experience, to avoid disappointments.
- ⇒ Follow the instructions carefully. Read and understand the entire step before you perform each operation.
- ⇒ Perform the assembly in the correct order as stated in this manual
- ⇒ Position all parts on the PCB (Printed Circuit Board) as shown on the drawings.
- ⇒ Values on the circuit diagram are subject to changes, the values in this assembly guide are correct\*
- ⇒ Use the check-boxes to mark your progress.
- ⇒ Please read the included information on safety and customer service

\* Typographical inaccuracies excluded. Always look for possible last minute manual updates, indicated as 'NOTE' on a separate leaflet.

### 1.3 Soldering Hints :

1- Mount the component against the PCB surface and carefully solder the leads



2- Make sure the solder joints are cone-shaped and shiny



3- Trim excess leads as close as possible to the solder joint



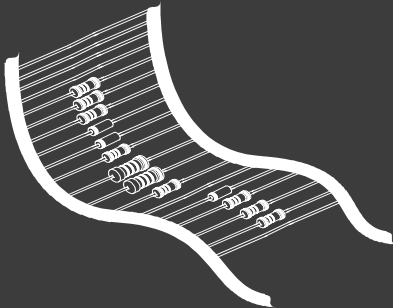

REMOVE THEM FROM THE TAPE ONE AT A TIME !

Included in  
this kit



## 2. RESISTOR

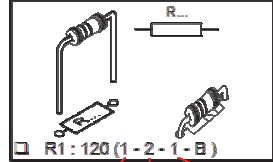

COLOUR	COLOUR NAME	1ST DIGIT/ STRIPE	2ND DIGIT/ STRIPE	3RD DIGIT/ STRIPE	MULTIPLIER STRIPE	TOLERANCE
Black	BLACK	0	0	0	x1	1%
Brown	BROWN	1	1	1	x10	
Red	RED	2	2	2	x100	
Orange	ORANGE	3	3	3	x1.000	
Yellow	YELLOW	4	4	4	x10.000	
Green	GREEN	5	5	5	x100.000	
Blue	BLUE	6	6	6	x1.000.000	

**DO NOT BLINDLY FOLLOW THE ORDER OF THE COMPONENTS ONTO THE TAPE.  
ALWAYS CHECK THEIR VALUE ON THE PARTS LIST!**

### 1. Jumper wire

- J : 1X

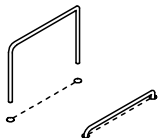

### 2. Diodes. Watch the polarity !

- D5 : 1N4148
- D6 : 1N4007

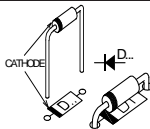

### 3. Zenerdiodes. Watch the polarity !

- ZD1 : 12V0
- ZD2 : 5V6

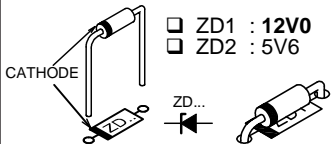

### 4. Metal film resistor

- R1 : 470K (4 - 7 - 4 - B - 9)

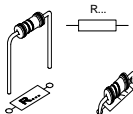

### 5. Resistor

- R7 : 2K2 (2 - 2 - 2 - B)

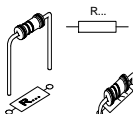

### 6. IC socket, watch the position of the notch !

- IC1 : 8P

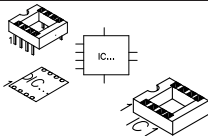

### 7. Capacitors.

- C1 : 10nF (103)
- C2 : 10nF (103)
- C3 : 10nF (103)
- C4 : 100nF (104)
- C5 : 100nF (104)
- C6 : 100nF (104)

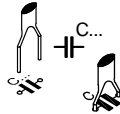

### 8. LED. Watch the polarity !

- LD1 : Yellow

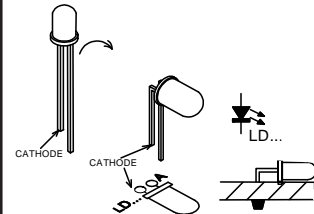

### 9. Diodes. Watch the polarity !

- D1 : 1N5408
- D2 : 1N5408
- D3 : 1N5408
- D4 : 1N5408

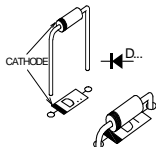

### 10. 1W resistors.

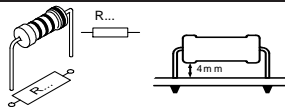

- R11 : 22K (2 - 2 - 3 - B)

**Choose operating voltage :**

For 110 - 125VAC :

- R12 : Jumper wire

For 220 - 240VAC :

- R12 : 22K (2 - 2 - 3 - B)

### 11. Transistors.

- T1 : BC547C
- T2 : BC547C
- T3 : BC547C

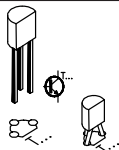

### 12. Vertical resistors

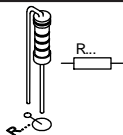

- R2 : 100K (1 - 0 - 4 - B - 9)
- R3 : 100K (1 - 0 - 4 - B - 9)
- R4 : 33K (3 - 3 - 3 - B)
- R5 : 33K (3 - 3 - 3 - B)
- R6 : 33K (3 - 3 - 3 - B)
- R8 : 10K (1 - 0 - 3 - B)
- R9 : 10K (1 - 0 - 3 - B)
- R10 : 470 (4 - 7 - 1 - B)

*R2 & R3 are metal film resistors.*

### 13. CoolMOS™ FET-transistor

- T4 : SPP20N60C3

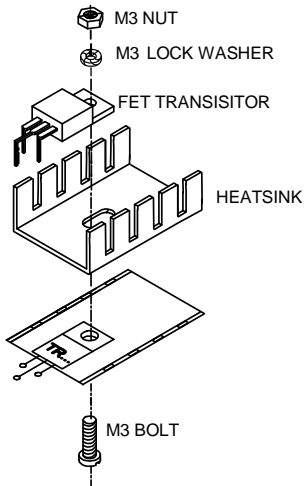

**14. Electrolytic Capacitors.  
Watch the polarity !**

- C7 : 10 $\mu$ F
- C8 : 220 $\mu$ F

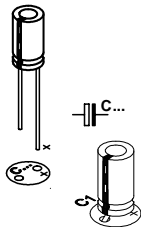

**CHECK THOROUGHLY ALL THE COMPONENTS FOR  
MISS MOUNTING, INCLUDING SOLDERING ERRORS.**

**15. IC, Check the position of  
the notch!**

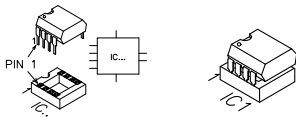

- IC1 : VK8068  
programmed PIC12F629

## 16. Installation & use

- Cut off the mains voltage of the K8006 (deactivate the main fuse of your switch box).
- Place the K8068 module into a free connector.
- Connect a load suitable for the specifications of this module !

*You can now activate your K8006*

Upon K8068 power-on, the LED (LD1) will flash briefly once (twice for 60Hz mains) during the internal diagnosis test. After this brief test, the module automatically switches to normal operation.

If the CPU detects irregularities during the self test or during operation, the module will switch to the ALARM position. The status LED will slowly flash once, followed by a number of shorter flashes (see "LED error indications ")

### **Use :**

Press any control button briefly to switch the light source on or off, or keep the button pressed to adjust the light intensity. When a dimming cycle reaches an end point (maximum luminosity or turned off), the dimming cycle will halt automatically.

To reverse the dimming direction, release the button for a moment and keep it pressed again.

The last used light intensity is saved in the internal memory when the light source is switched off by briefly pressing the control button. This light intensity is also saved in case of a power failure. For safety reasons, the lamp will not switch on again after a power failure.



### **LED indications in case of normal operation:**

- ✓ Flashes once every 5 seconds when the module is in standby mode (lamp OFF).
- ✓ Flashes twice per second when the lighting is dimmed.
- ✓ Flashes 5x per second when the lighting is on at full brightness.
- ✓ Flashes once per second during a dimming cycle.

### **LED indications in case of error:**

When an error is reported, the status LED is lit for a while and then flashes a number of times. The number of flashes indicates what problem has occurred.

Number of flashes	Error	possible cause / solution
1	Time-out in the positive alternation of the mains voltage during operation.	Error in the voltage zero crossing circuit in charged condition (circuit T1, power failures on the mains, charge not compatible with module...)
2	Time-out in the negative alternation of the mains voltage during operation	Error in the voltage zero crossing circuit in charged condition (circuit T1, power failures on the mains, charge not compatible with module...)
3	Time-out in the positive alternation of the mains voltage during self test.	Error in the voltage zero crossing circuit in uncharged condition (circuit T1...)
4	Time-out in the negative alternation of the mains voltage during self test.	Error in the voltage zero crossing circuit in uncharged condition (circuit T1...)
5	Mains frequency is too high. Freq. > 62 Hz.	Check your local mains frequency. It should be 50 or 60 Hz. There may be power failures on the mains.
6	Mains frequency is too low. Freq. < 48 Hz.	Check your local mains frequency. It should be 50 or 60 Hz. There may be power failures on the mains.

## 17. PCB layout.

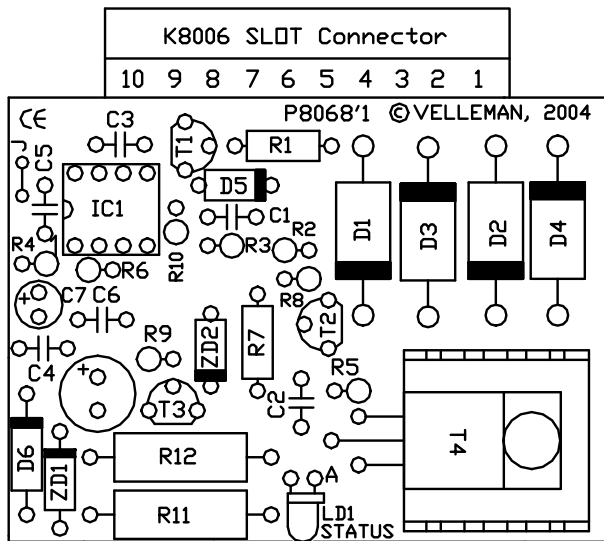

18. Diagram

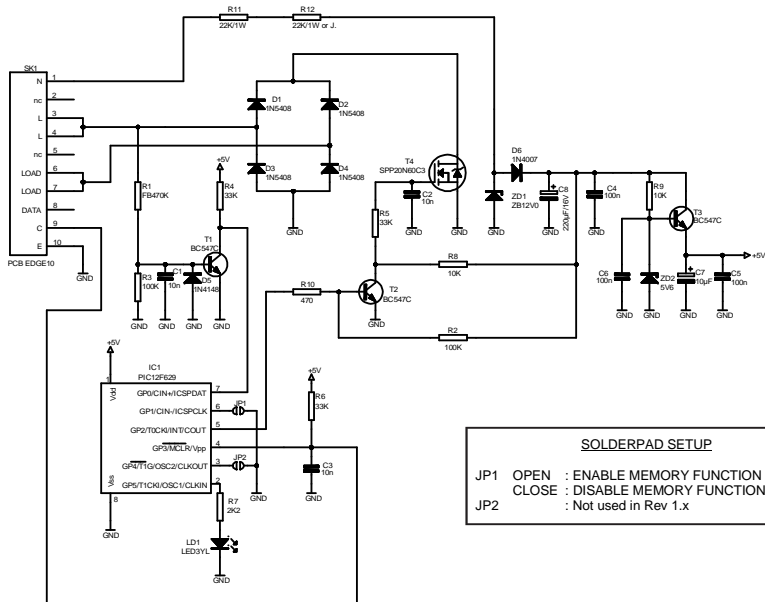

**EDU 01****SOLDERLESS EDUCATIVE STARTERBOX**

The EDU01 basic experiment kit is the first step into the world of modern electronics. Build your own circuits in a fun, safe and educative way.

**AVAILABLE****EDU 02****SOLAR ENERGY EXPERIMENT KIT**

Fun solar powered projects. Learn all about solar energy.

**AVAILABLE****EDU 03****SOLDER EDUCATIVE STARTER BOX**

Learn how to solder, build different exciting projects. Includes spare components and demo boards.

**COMING SOON****EDU 04****PIC™ TUTOR KIT**

Enter the world of microcontroller programming, easy step by step instructions. Includes programmer and test board.

**COMING SOON****EDU 05****USB TUTOR BOARD**

Learn how to connect your computer with the outside world, master the USB communication with tutorial examples. Play with LED indicators and learn how to drive LCD displays.

**COMING SOON****EDU 06****SCOPE EDUKIT**

This board with different signals will teach you how to use an oscilloscope. Optimized instructions for use of our HPS140 oscilloscope. YouTube demo movies.

**COMING SOON**