



**A** Parts mounted at solder side! - Onderdelen langs de soldeerzijde! - Eléments du côté soudure! - Elemente entlang der Lötseite! - Elementos del lado soldadura! - Delar monterade på kretskortets lötsida - Parti dal lato dove bisogna saldare! - Komponenter, monteret på loddessiden! - Osat asennetaan juotospuolelle! - Partes montadas no lado da soldadura.

**1**

Resistor -  
Weerstand -  
Résistance -  
Widerstand -  
Resistencia -  
Motstand -  
Vastus -  
Resistenze

- ◇ R1... R6: 470 (Yellow, Purple, Brown) -(Geel, Paars, Bruin) -(Jaune, Violet, Brun) -(Gelb, Violet, Braun) -(Gul, Lila, Brun) -(Keltainen, Purppura, Ruskea) -(Amarillo, Morado, Marrón) -(Amarelo, Violeta, Castanho) -(Giallo, Viola, Marrone)
- ◇ R7... R32: 1K (Brown, Black, Red) -(Bruin, Zwart, Rood) -(Brun, Noir, Rouge) -(Braun, Schwarz, Rot) -(Brun, Svart, Röd) -(Ruskea, Musta, Punainen) -(Marrón, Negro, Rojo) -(Castanho, Preto, Encarnado) -(Marrone, Nero, Rosso)
- ◇ R33... R36: 3K3 (Orange, Orange, Red) -(Oranje, Oranje, Rood) -(Orange, Orange, Rouge) -(Orange, Orange, Rot) -(Orange, Orange, Röd) -(Oranssi, Oranssi, Punainen) -(Naranjado, Naranjado, Rojo) -(Laranja, Laranja, Encarnado) -(Aranciato, Aranciato, Rosso)
- ◇ R37... R41: 47K (Yellow, Purple, Orange) -(Geel, Paars, Oranje) -(Jaune, Violet, Orange) -(Gelb, Violet, Orange) -(Gul, Lila, Orange) -(Keltainen, Purppura, Oranssi) -(Amarillo, Morado, Naranjado) -(Amarelo, Violeta, Laranja) -(Giallo, Viola, Aranciato)

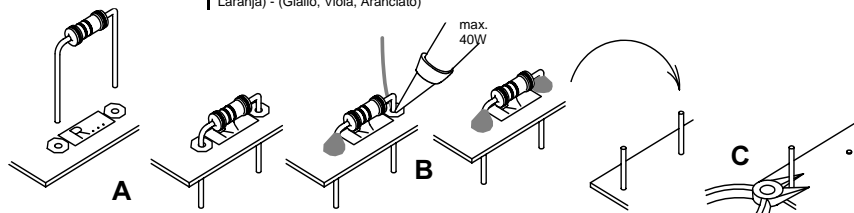
**2**

Transistor

- ◇ T1... T6: BC557
- ◇ T7, T8: BC547

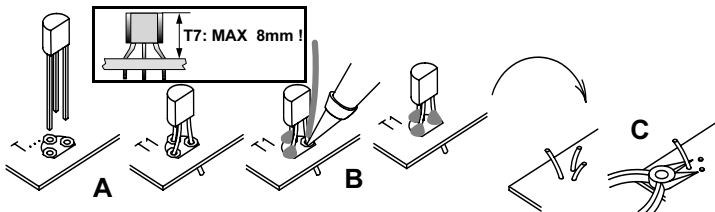
**3**

- ELCO ◇ C1, C2, C3: 2µ2 Watch the polarity! - Att. la polarità!  
◇ C4, C5: 10µF

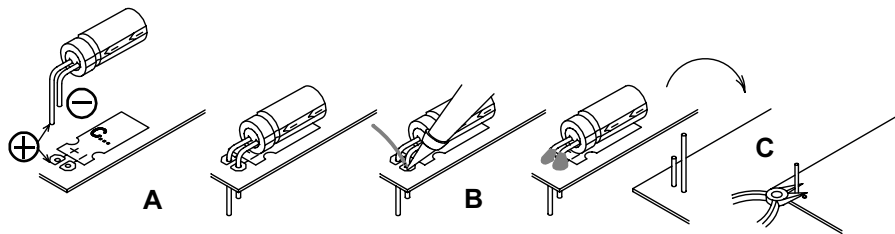

**B** Parts mounted at component side! - Onderdelen langs de componenten zijde! - Eléments du côté composants! - Elemente entlang der Bauteilseite! - Elementos del lado componentes! - Delar monterade på kretskortets komponentsida! - Parti dal lato dove si trovano i componenti! - Komponenter, monteret på komponentsiden! - Osat asennetaan komponenttipuolelle! - Partes montadas no lado dos componentes.

**4**

LED 3mm

- ◇ 28 X = Green, Groen, Vert, Grün, Grön, Vihreä, Verde
- ◇ 51X = Yellow, Geel, Jaune, Gelb, Gul, Keltainen, Amarillo, Amarelo, Giallo.
- ◇ 47X = Red, Rood, Rouge, Rot, Röd, Punainen, Rojo, Encarnado, Rosso.

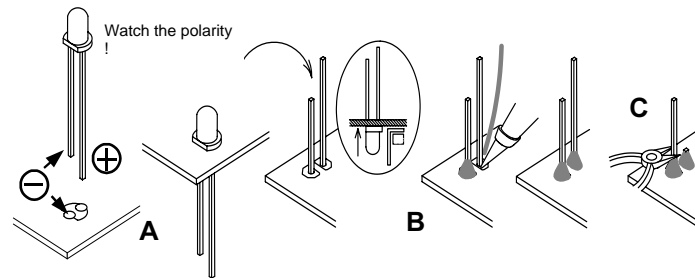
**5**

◇ DC Jack

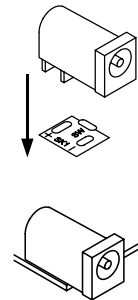
**6**

◇ SW1

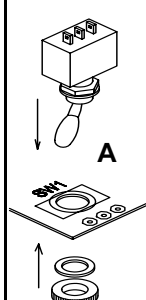

- Mount the switch and make the connections.
- Monteer de schakelaar en maak de verbindingen.
- Montez l'interrupteur et faites la connexion.
- Montieren Sie den Schalter und legen Sie die Verbindung.
- Montera strömbrytaren, och löd anslutningarna.
- Montar el interruptor y hacer la conexión
- Montare l'interruttore e collegare.
- Monter kontakten, og træk ledningerne
- Asenna kytkin ja tee kytkentä.
- Montar o interruptor e fazer as restantes ligações

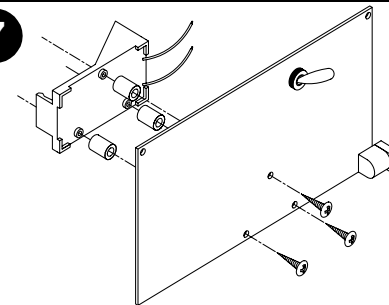
**7**

Red, Rood, Rouge, Rot, Röd, Punainen, Rojo, Encarnado, Rosso.

