



# VMB1TS

## Temperature sensor module for the Velbus system



## CONTENTS

<b>DESCRIPTION</b> .....	<b>3</b>
<b>CHARACTERISTICS</b> .....	<b>3</b>
<b>VELBUS CHARACTERISTICS</b> .....	<b>5</b>
<b>OVERVIEW SENSOR MODULE</b> .....	<b>7</b>
<b>EMBEDDING THE TEMPERATURE SENSOR</b> .....	<b>8</b>
<b>EMBEDDING A TEMPERATURE SENSOR TOGETHER WITH A CONTROLLER</b> .....	<b>9</b>
<b>OVERVIEW HEATING INSTALLATION</b> .....	<b>10</b>
<b>WIRING</b> .....	<b>11</b>
Connecting the temperature sensor VMB1TS .....	11
Connecting the temperature controller VMB1TC .....	11
Relay cabinet wiring .....	12
Terminator .....	13
Addressing .....	13
<b>LED INDICATION</b> .....	<b>14</b>
Anti-freeze, night, day or comfort mode .....	14
Cooling or heating mode .....	14
Air-conditioner or heater active .....	14
<b>OPERATION</b> .....	<b>15</b>
<b>SETTINGS</b> .....	<b>16</b>
Preset range .....	16
Zones .....	16
Protecting the circulation pump and/or heating valves .....	16
Time statistics .....	17
Minimum and maximum temperature .....	17
Differential thermostat .....	17
Factory settings .....	17
<b>CONFIGURING THE OUTPUTS</b> .....	<b>18</b>
Allocate a relay channel to control a valve .....	19
Allocate a relay channel to control the fan (boost) .....	20
Allocate a relay channel to set the boiler in day mode .....	21
Allocate a relay channel to steer an air-conditioner .....	22
Allocate a relay channel for the circulation pump .....	23
Allocate a relay channel for the low temperature alarm .....	24
Allocate a relay channel for the high temperature alarm .....	25
<b>REMOTE CONTROL</b> .....	<b>26</b>
Remotely control comfort mode .....	27
Remotely control day mode .....	28
Remotely control night mode .....	29
Remotely control anti-freeze mode .....	30
Remotely set heating mode .....	31
Remotely set cooling mode .....	32
Remotely lock local operation .....	33
Remotely unlock local operation .....	34
Deleting an assigned pushbutton .....	35
Deleting all assigned pushbuttons for a certain function .....	36
Deleting all assigned pushbuttons .....	37
<b>SWITCHING TO ANTI FREEZE MODE THROUGH WINDOW CONTACTS</b> .....	<b>38</b>
<b>DIFFERENTIAL THERMOSTAT</b> .....	<b>39</b>
The passage automatically 3° cooler than the office .....	40
Passive cooling of a bedroom .....	41
<b>VERIFY SOFTWARE VERSION</b> .....	<b>42</b>

## DESCRIPTION

The sensor module can be used to measure and send temperatures over the Velbus-system. In combination with a relay module (VMB4RY or VMB1RY) a thermostat can be set-up to control a heating or cooling installation. Setting the comfort, day, night or anti-freeze mode can be done via the local pushbutton or with pushbuttons that are connected to the Velbus. Different sensors can be configured and controlled from a remote location through a temperature controller (VMB1TC) or via a PC interface (VMB1USB, VMB1RS or VMBRSUSB) and the Velbus link software.

The temperature controller (VMB1TC) can also include program instructions to control different sensors.

## CHARACTERISTICS

- ◇ Temperature range of the sensor: -10° to 63.5°C (14° to 146°F)
- ◇ precision after calibration:
  - ±0.5°C at 25°C
  - ±1°C between -10°C and 63.5°C
- ◇ Resolution: 0.0625°C
- ◇ Hysteresis: 0°C to 15.5°C (interval of 0.5°C)
- ◇ Possibility to automatically send the ambient temperature over the Velbus
- ◇ Registration of minimum and maximum temperature
- ◇ Registration on-time of heater/air-conditioner
- ◇ Thermostat function for cooling or heating
- ◇ In combination with a second sensor a differential thermostat can be created
- ◇ Range:
  - heating function: -32°C to 54°C in steps of 0.5°C (default settings: 5° to 30°)
  - cooling function: -32°C to 54°C in steps of 0.5°C (default settings: 16° to 36°C)
- ◇ Relay steering via Velbus for:
  - heating
  - fast heating/cooling
  - heating boiler in day mode
  - cooling
  - steering circulation pump
  - alarm at low temperature
  - alarm at high temperature
- ◇ Cycling protection delay on heating and cooling outputs (minimum on/off switching delay): 1 minute default (can be switched off or set in multiples of minutes via Velbuslink software)
- ◇ Selectable unjamming function for the circulation pump and/or heating valves (min. 1 minute/day on)
- ◇ Control:
  - local pushbutton
  - remotely via pushbuttons connected to the Velbus
  - via temperature controller VMB1TC
  - through Velbus program instructions
- ◇ Local control for switching between:
  - comfort mode
  - day mode
  - night mode
  - safeguard mode (anti-freeze)
- ◇ Possibility to prevent (lock) local control
- ◇ Control through pushbuttons connected to the Velbus to:
  - set the module to comfort temperature
  - set the module to day temperature
  - set the module to night temperature
  - set the module to safeguard temperature (anti-freeze)
  - set the thermostat to heating
  - set the thermostat to cooling
  - lock the local control
  - unlock the local control
- ◇ Heating can be set in anti freeze mode through window contacts connected to the Velbus when a window is opened
- ◇ Feedback to the pushbutton modules to update the LED status
- ◇ Can be programmed without the aid of a PC
- ◇ Simple learning process by pressing the desired pushbuttons while in learning mode

- ◇ Storage capacity of 10 different pushbuttons per control function
- ◇ LED indications for:
  - thermostat function for cooling
  - comfort mode
  - day mode
  - night mode
  - heater/air-conditioning status
  - power supply voltage
  - receiving/transmitting data over the Velbus
- ◇ Settings for:
  - the desired temperature
  - the desired comfort temperature for heating
  - the desired day temperature for heating
  - the desired night temperature for heating
  - the anti-freeze safeguard temperature
  - the heating limit (upper limit of the heating preset range)
  - the desired comfort temperature for cooling
  - the desired day temperature for cooling
  - the desired night temperature for cooling
  - the lower limit of the cooling preset range
  - the upper limit of the cooling preset range
  - the hysteresis
  - calibration of the sensor
  - the temperature difference for fast heating/cooling or for the differential thermostat
  - the low temperature alarm (alarm when temperature drops below this value)
  - the high temperature alarm (alarm when temperature rises above this value)
  - the duration of temporary mode: from 1 to 65.279 minutes (45 days, 7 hours, 59 minutes)
  - transmitting the current temperature over the Velbus:
    - only when requested
    - only when changes occur
    - at specific time intervals, selectable between 10 and 255 seconds (4 minutes 15 seconds)
  - resetting minimum and maximum temperature
  - the zone (each sensor can belong to a specific zone)
  - the address of the linked sensor to set up a differential thermostat
  - cycling protection delay (minimum on/off switching delay)
- ◇ Change settings through Velbus instructions or via a temperature controller (VMB1TC)
- ◇ Control through a program stored in a temperature controller (VMB1TC)
- ◇ Different modes:
  - automatic: the sensor module accept all program instructions
  - temporary manual: program instructions are ignored during a specific period of time
  - manual: all program instructions are ignored and local control is locked
- ◇ The learned pushbutton functions and settings are retained when voltage drop-outs occur
- ◇ 246 possible addresses (setting via rotary switches)
- ◇ Required power supply: 12 to 18VDC
- ◇ Consumption when not in use: 12mA
- ◇ Maximal consumption: 15mA
- ◇ Dimensions (W x H x D): 43 x 46 x 22mm

## VELBUS CHARACTERISTICS

- 2-wire communication for Velbus data and 2 wires for power supply
- data transmission: 16.6 Kbit/s
- Serial data protocol: CAN (Controller Area Network)
- Short circuit proof (towards negative or positive pole of the power supply)
- LED indication when receiving or transmitting data over the Velbus
- bus error indication: 2 short flashes of the LEDs
- auto recovering after 25 seconds when a bus error occurs

The sensor module can be given a designation with a maximum of 16 characters.

### **The temperature sensor module can transmit following messages:**

- output status
- manual pushbutton status
- sensor status
- sensor temperature, minimum and maximum temperature
- time statistics (heating/air-conditioning on time)
- sensor settings
- sensor configuration
- module type (including zone number and software version)
- sensor name
- memory content
- the communication error counter

### **The temperature sensor module can transmit following instructions:**

- change the status of the LED(s) on the pushbutton module
- switching off the LED(s) on a pushbutton module
- switching on the LED(s) on a pushbutton module
- make LED(s) on a pushbutton module flash slowly
- make LED(s) on a pushbutton module flash fast
- the desired temperature for the linked sensor to create a differential thermostat

### **The temperature sensor module can receive following messages:**

- the status of a pushbutton module

### **The temperature sensor module can receive following instructions:**

- to set:
  - the desired temperature
  - the desired comfort temperature for heating
  - the desired day temperature for heating
  - the desired night temperature for heating
  - the anti-freeze safeguard temperature
  - the heating limit
  - the desired comfort temperature for cooling
  - the desired day temperature for cooling
  - the desired night temperature for cooling
  - the lower limit of the cooling preset range
  - the upper limit of the cooling preset range
  - the hysteresis
  - calibration of the sensor
  - the temperature difference for fast heating/cooling or for the differential thermostat
  - the temperature difference for fast heating or cooling
  - the alarm temperatures
  - the default duration of temporary mode (sleep time)
  - the zone number
  - the address of the linked sensor to set up a differential thermostat
- to determine:
  - heating
  - cooling

- local control panel:
  - lock
  - unlock
- memory:
  - read
  - (over)write
- set the status of the output LED
- switching off the indication LED on the pushbutton module(s)
- switch unjam function of circulation pump and/or heating valve on or off
- output LED handling:
  - switch off
  - switch on
  - flash
  - flash slowly
  - flash (very) fast
- request:
  - module type
  - content of the communication error counter
  - the sensor temperature (min/max) and setting the time interval for transmitting data
  - the time statistics
  - the sensor status
  - the sensor settings
  - the sensor configuration
  - the sensor name
- resetting:
  - minimum temperature
  - maximum temperature
  - time statistics
- switching to:
  - comfort mode
  - day mode
  - night mode
  - anti-freeze mode

## OVERVIEW SENSOR MODULE

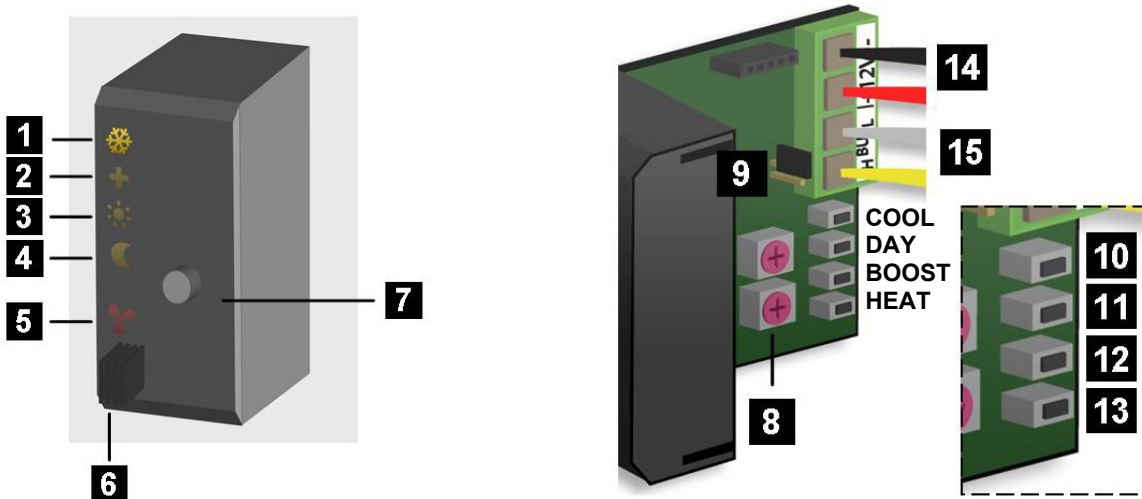

### LED indication

- |          |                                |
|----------|--------------------------------|
| <b>1</b> | Cooling mode                   |
| <b>2</b> | Comfort mode                   |
| <b>3</b> | Day mode                       |
| <b>4</b> | Night mode                     |
| <b>5</b> | Heating or air-conditioning on |

### Sensor

- |          |                    |
|----------|--------------------|
| <b>6</b> | Temperature sensor |
|----------|--------------------|

### Controls

- |          |                 |
|----------|-----------------|
| <b>7</b> | Mode pushbutton |
|----------|-----------------|

### Settings

- |          |                 |
|----------|-----------------|
| <b>8</b> | Address setting |
| <b>9</b> | Terminator      |

### Manual control

- |             |  |
|-------------|--|
| <b>10</b>   | (COOL) cooler                            |
| <b>11</b>   | (DAY) central heating system in day mode |
| <b>12</b>   | (BOOST) boost heater/cooler              |
| <b>13</b>   | (HEAT) heater                            |
| <b>7+11</b> | (Mode + DAY) high temp.alarm             |
| <b>7+12</b> | (Mode + BOOST) low temp.alarm            |
| <b>7+13</b> | (Mode + HEAT) pump                       |

### Wiring

- |           |                          |
|-----------|--------------------------|
| <b>14</b> | Power supply 12 to 18Vdc |
| <b>15</b> | Velbus                   |

## EMBEDDING THE TEMPERATURE SENSOR

The temperature sensor VMB1TS can be embedded in combination with 2 blank frames VMBFBI and a Velbus cover plate VMBFDG or VMBFLG.

Push the modules from the back into the cover plate

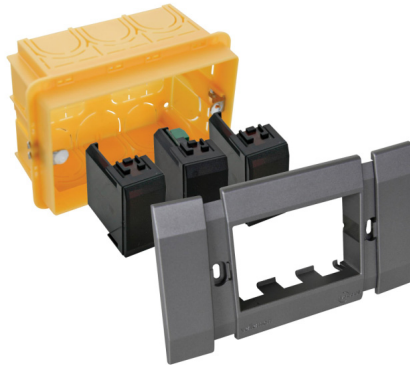

It is also possible to use a 2- or 3-module wide frame with cover plate from the BTicino Living series. The module must be pushed into the build-in frame from the front



It is also possible to use a 3-module wide frame with cover plate from the BTicino Light or Light Tech series. The module must be pushed into the build-in frame from the front.

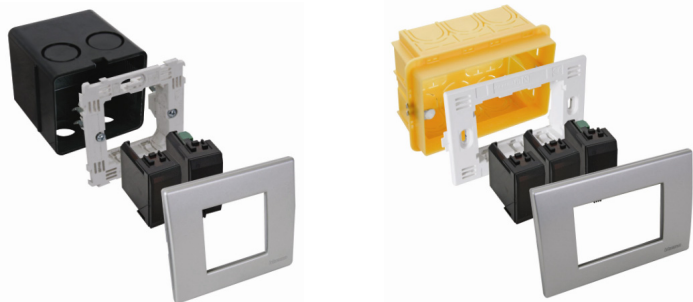

To build the sensor in into a hollow wall, use a hollow wall pattress.





## EMBEDDING A TEMPERATURE SENSOR TOGETHER WITH A CONTROLLER

The sensor (VMB1TS) can be embedded together with a controller (VMB1TC) in a 4-module wide frame with cover plate from the BTicino Living series. The module must be pushed into the build-in frame from the front.



The sensor (VMB1TS) can be build-in together with a controller (VMB1TC) in a 4-module wide frame with cover plate from the BTicino Light of Light Tech series. The module must be pushed into the build-in frame from the front



To build the controller and sensor in into a hollow wall, use a hollow wall pattress.



## OVERVIEW HEATING INSTALLATION

A heating installation usually consists of radiators or convectors, a boiler, circulation pump and a collector with valves for every radiator group.

Every room is equipped with a temperature sensor VMB1TS which is controlled by one or multiple temperature controllers VMB1TC. The sensors in turn steer the relay modules VMB4RY (or VMB1RY) that control the valves. As soon as one of the valves is opened, a relay channel can activate the circulation pump and when one of the sensors is in day or comfort mode, a relay channel can put the boiler in day mode.

When convectors with built-in fan are used, a relay channel can steer this fan in case the room temperature deviates too much from the desired temperature, e.g. to speed up heating in the morning.

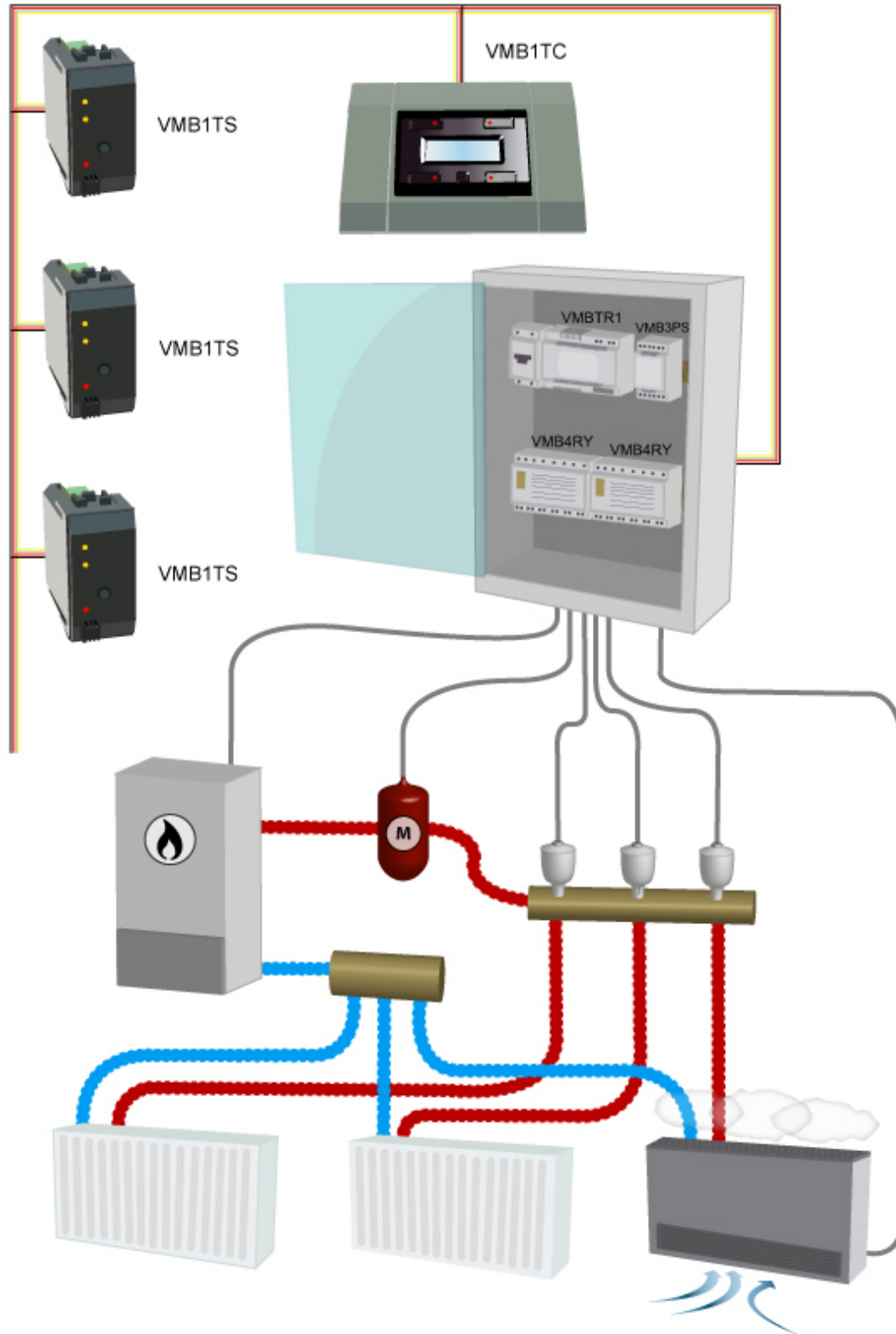

## WIRING

To interconnect the Velbus modules the use of twisted-pair cable (EIB 2x2x0.8mm<sup>2</sup>, UTP 8x0.51mm - CAT5 or equivalent) is recommended.

When a lot of modules (more than 10) are connected to the cable or longer cable lengths (more than 50m) are used, it is important to use a cable with appropriate diameter (0.5mm<sup>2</sup> or higher).

Connect the bus to the module (beware of the polarity).

Connect the 12V to 18V direct current to the module (beware of the polarity).

### Connecting the temperature sensor VMB1TS

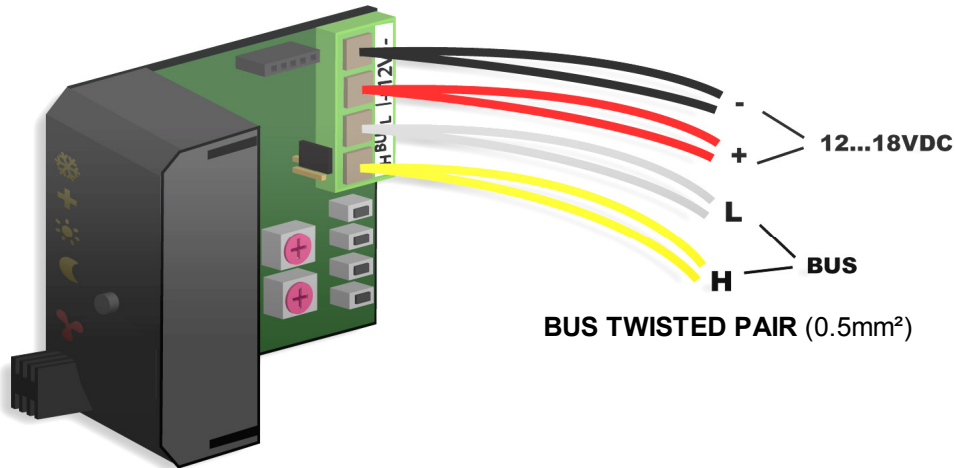

### Connecting the temperature controller VMB1TC

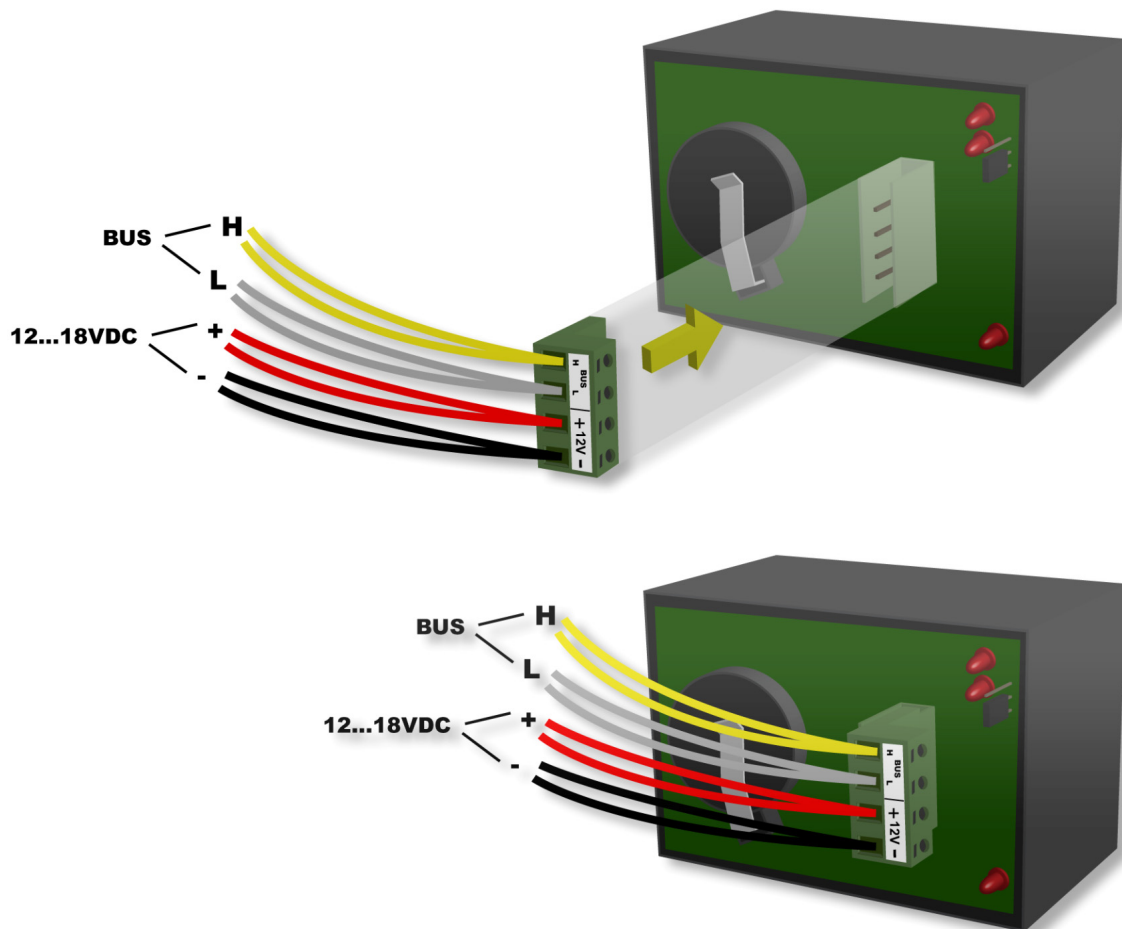

# Relay cabinet wiring

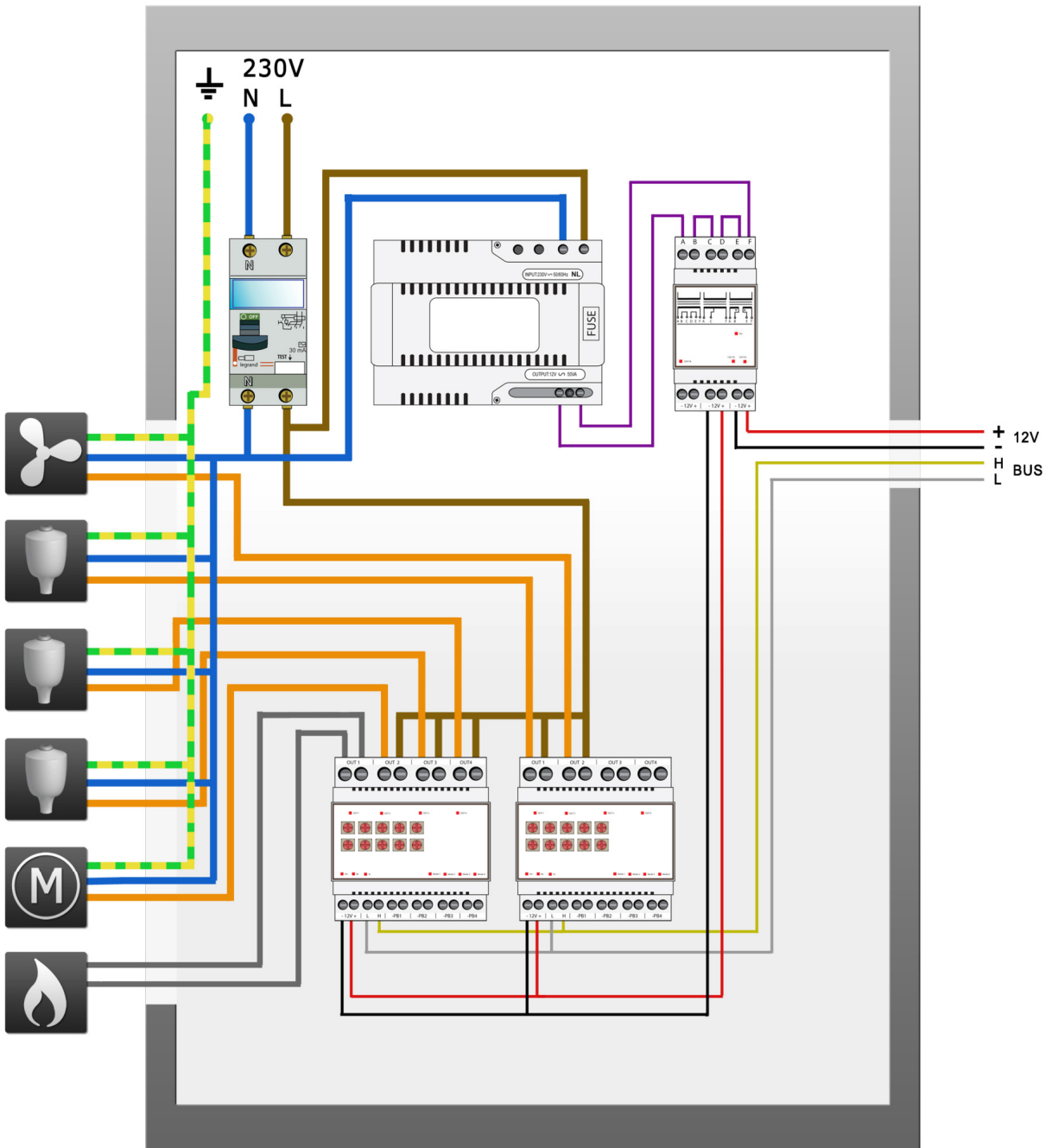

## Terminator

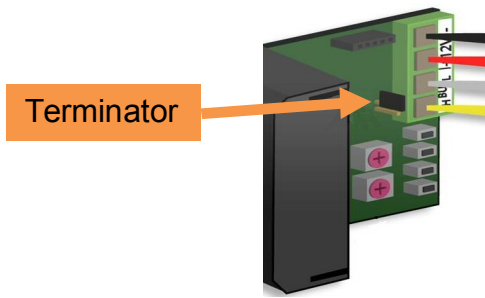

Normally only 2 'TERM' terminators must be used in a complete Velbus installation. Usually this will be on one module inside the distribution box and on the module which is physically located furthest from the distribution box.



On all other modules, the terminator must be removed.



### Remark:

In case the wiring contains a lot of branches, still only one terminator is placed on one module inside the distribution box and one on the module which is physically located furthest from the distribution box. When communication errors occur, an additional terminator can be used at the end of another branch. However, the number of terminators should be limited as more terminators place a heavy load on the bus.

## Addressing

Every module on the Velbus system must have its own unique address.

On modules with a rotary switch e.g. the temperature sensor VMB1TS and the relay module VMB4RY the address is set using the 'ADDR' rotary switch (also refer to the manual of the relevant module).

The address of the temperature controller VMB1TC is set via a menu (refer to the manual of the temperature controller).

These addresses may not be altered afterwards.

Set a unique Velbus address for the temperature using the 'ADDR' rotary switches, from '00' to 'FE', except the reserved addresses: '81', '91', 'A1', 'B1', 'C1', 'D1', 'E1', 'F1' en 'FF'.

The example below shows the setting for address 'A5'.

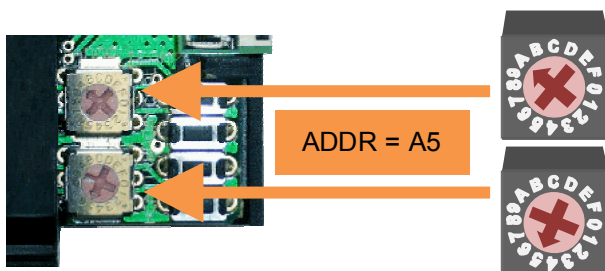

### Anti-freeze, night, day or comfort mode

In rooms that have a temperature sensor VMB1TS the heating (or air-conditioning) can be set in 4 different modes: comfort, day, night or anti-freeze. Every mode has its own desired temperature setting.

The selected mode is indicated with LEDs.

The sensor module is set to anti-freeze mode when the comfort, day and night mode LEDs are off.

When the comfort, day or night mode LED is flashing, the sensor module is set temporarily (sleep timer) to the indicated mode and normal program is suspended during that 'sleep' time.

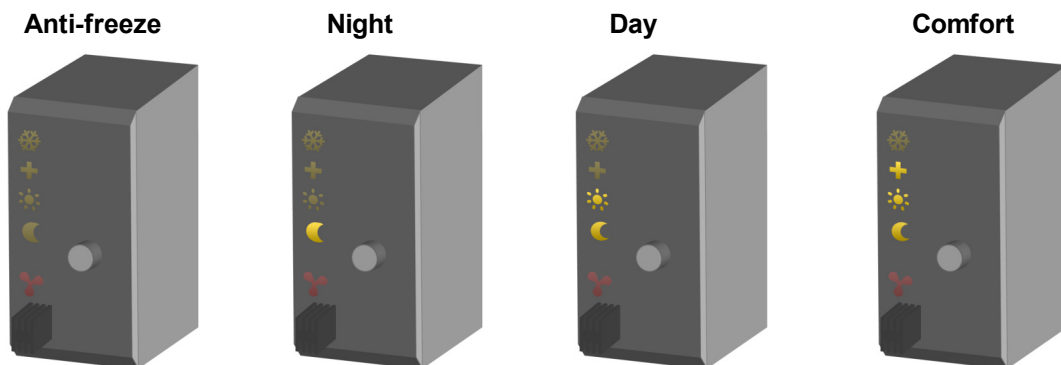

### Cooling or heating mode

When the temperature sensor is configured to control an air-conditioning system, the frost flower LED (upper LED) will be lit.

Setting the heating or cooling mode can only be done through a temperature controller (VMB1TC) or through the Velbus link program.

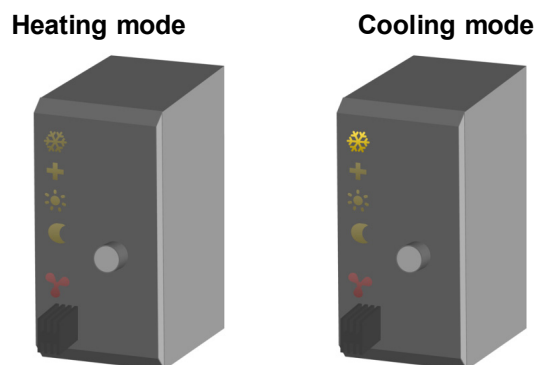

### Air-conditioner or heater active

When the heater (valve open) or air-conditioner is active, a red LED will be lit.

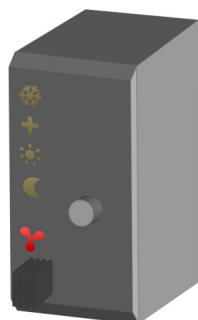

The red output LED can indicate following error conditions:

- *Flashing (short on, long off): the heater/cooler should be **off** but it did not receive the command from the relays module.*
- *Flashing (short off, long on): the heater/cooler should be **on** but it did not receive the command from the relays module.*
- *Fast flashing: configuration of the sensor chip failed.*

*Note: as long as the error condition exists the output status will be re-transmitted every minute.*

## OPERATION

Pushing the push button repeatedly will switch the module between anti-freeze, night, day or comfort mode successively.

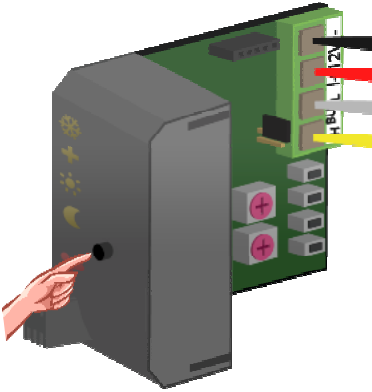

When the comfort, day or night mode LED is flashing, the sensor module is set temporarily (sleep timer) to the indicated mode. During this time the program is ignored

When the sleep timer expires, the sensor module will resume the program or in case no program is present will return to its previous setting.

### **Remarks:**

- Anti-freeze mode can not be set temporarily.
- Standard time is set through the temperature controller.
- Overriding temporary mode can be done by pushing and holding the push button. The LED stops flashing and the sensor remains in the selected mode until the next program step is executed.
- Local operation can be locked or unlocked via a temperature controller VMB1TC or via the Velbus link program.
- When the sensor module is set to manual mode via a temperature controller VMB1TC or via the Velbus link program, local operation will be locked.

## SETTINGS

Following parameters can be set via the temperature controller (see manual VMB1TC) or via the Velbus link software:

- the zone to which the sensor belongs
- the operating mode (heating or cooling)
- switching the unjam function of the circulation pump and/or heating valve on or off
- the desired comfort temperature for heating
- the desired day temperature for heating
- the desired night temperature for heating
- the anti-freeze safeguard temperature
- the heating limit (upper limit of the heating preset range)
- the temperature difference for fast heating/cooling or for the differential thermostat
- the desired comfort temperature for cooling
- the desired day temperature for cooling
- the desired night temperature for cooling
- the lower limit of the cooling preset range
- the upper limit of the cooling preset range
- the hysteresis
- calibration of the sensor
- the alarm temperatures
- the duration of temporary mode
- the zone number
- the low temperature alarm (alarm when temperature drops below this value)
- the high temperature alarm (alarm when temperature rises above this value)
- the duration of temporary mode: from 1 to 65.279 minutes (45 days, 7 hours, 59 minutes)
- transmitting the current temperature over the Velbus:
  - only when requested
  - only when changes occur
  - at specific time intervals, selectable between 10 and 255 seconds (4 minutes 15 seconds)
- resetting minimum and maximum temperature
- reset time registration for the heater/air-conditioning
- locking or unlocking local control
- the address of the linked sensor to set up a differential thermostat
- sensor name (max. 16 characters)

The cycling protection delay (delay setting is 1 minute) can be modified through the Velbuslink software if the software version of the sensor module is 0949 or higher (see "Verify software version").

### **Preset range**

The preset range for the desired temperature can be adjusted by the user. This is a way to make sure that the heating can never be set higher than a certain value.

### **Zones**

A zone can be useful when the desired temperature of different rooms must follow the same pattern. This way only one program must be set-up for all rooms that belong to that zone.

Every sensor of that zone must get the same zone number assigned. Up to 7 zones can be defined.

Assigning a zone can be done via the temperature controller (VMB1TC) or through the Velbus link software via a PC connected to the Velbus PC interface (VMB1USB, VMB1RS or VMBSUSB).

### **Protecting the circulation pump and/or heating valves**

When a circulation pump or a valve is not being used for some time, it might get stuck. To avoid this, an unjamming function can be enabled which activates the pump or opens the valve for at least one minute every day.

Enabling or disabling the unjam function can be done via the temperature controller (VMB1TC) or through the Velbus link software via a PC connected to the Velbus PC interface (VMB1USB, VMB1RS or VMBSUSB).



## Time statistics

For every mode (comfort, day, night or anti-freeze) the time during which the heating or air-conditioning was on is stored.

These statistics can be recalled or reset via the temperature controller (VMB1TC) or through the Velbus link software via a PC connected to the Velbus PC interface (VMB1USB, VMB1RS or VMBRSUSB).

## Minimum and maximum temperature

The sensor records the minimum and maximum temperature.

These values can be examined or reset via the temperature controller (VMB1TC) or through the Velbus link software via a PC connected to the Velbus PC interface (VMB1USB, VMB1RS or VMBRSUSB).

## Differential thermostat

Using two sensors a differential thermostat can be created. When the difference in temperature between both sensors reaches a certain value, the relay channel can be activated.

To achieve this, the first sensor must know the address of the second one. The second sensor must then be linked to a relay channel. The temperature difference value is set on the first sensor.

## Factory settings

After receiving this module, following factory default settings are already stored into the sensor:

Description	Factory default
Zone number	No zone
Differential sensor address	None
Operating mode	Heating
Unjam heating valve	Disabled
Unjam heating valve circulation pump	Disabled
Desired comfort temperature for heating	22°C
Desired day temperature for heating	20°C
Desired night temperature for heating	15°C
Anti-freeze safeguard	5°C
Heating limit	30°C
Temperature difference (fast heating/cooling or differential thermostat)	3°C
Calibration factor	-2.5°C
Hysteresis	0.5°C
Desired comfort temperature for cooling	21°C
Desired day temperature for cooling	23°C
Desired night temperature for cooling	26°C
Lower limit cooling preset range	16°C
Upper limit cooling preset range	36°C
Low temperature alarm	3°C
High temperature alarm	30°C
Default duration temporary mode (sleep timer)	1 hour
Time interval for automatic transmission temperature	Disabled
Local control	Unlocked
Cycling protection delay	1 minute

## CONFIGURING THE OUTPUTS

The sensor module transmits messages over the Velbus when the status of one of its multiple outputs changes. Relay modules (VMB1RY or VMB4RY) can be linked to these Velbus messages to perform the following functions:

- steering the heating valve
- switching the heating or cooling installation to boost mode when the difference in desired and current temperature is too big
- set the heating boiler in day mode
- steering the air-conditioning
- steering the circulation pump of the heating installation
- generate an alarm when the temperature is too low (heating system down)
- generate an alarm when the temperature is too high (a valve does not close anymore)

Every relay channel that is steered by a temperature sensor must be set to momentary (instant) control. For this, on the relay module the TIME1 and MODE/TIME2 rotary switches of the channel must be set to position '0'.

The easiest way to allocate those relay channels is through the use of the Velbus link software via a PC connected to a Velbus PC interface (VMB1USB, VMB1RS or VMBRSUSB).

However, it can be done without the use of a computer as described in the following procedures.

## Allocate a relay channel to control a valve

When room temperature drops below the desired value, the temperature sensor sends a request on the bus to energize the relay that opens the valve. When the room temperature rises above the desired value, another request by the temperature sensor is transmitted over the bus to de-energize the relay thus to close the valve. In this example, relay channel 1 is used to steer the heating valve.

1. Set the sensor module in anti-freeze mode by pressing the push button on the front panel repeatedly until all LEDs are off.

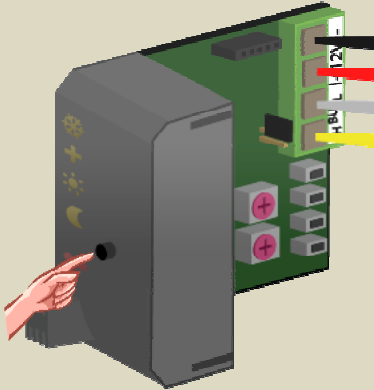

2. Set the MODE and TIME1 rotary switches for channel 1 of relay module to '0' (instant control).
3. Remember the address of this relay module to reinstate it later on.
4. Set the address of the relay module to 'C1'. The 'MODE 1' LED flashes to indicate push button learning mode (PBM).

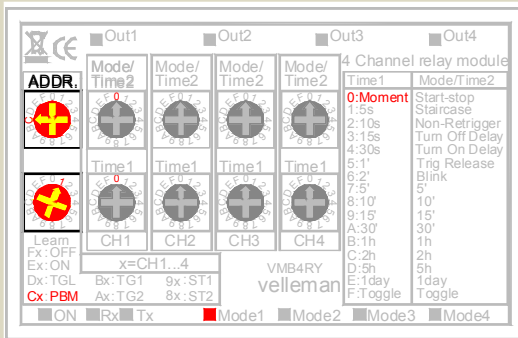

5. Press and hold the lowest push button (HEAT) of the temperature sensor until the relay is energised and the red LED on the sensor module flashes.

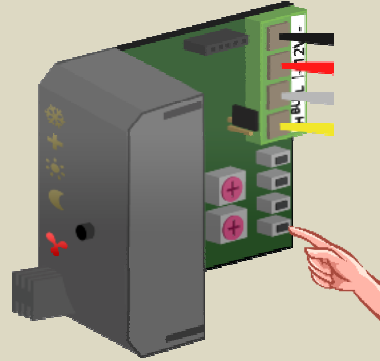

6. Set the address of the first relay module back to its original value.

## Allocate a relay channel to control the fan (boost)

Some convector types have a built-in fan for fast heating when the current temperature differs too much from the desired.

In this example the fan is steered by relay channel 2.

1. Set the sensor module in anti-freeze mode by pressing the push button on the front panel repeatedly until all LEDs are off.

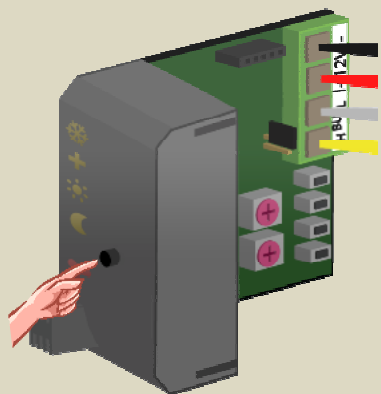

2. Set the MODE and TIME1 rotary switches for channel 2 of relay module to '0' (instant control).
3. Remember the address of this relay module to reinstate it later on.
4. Set the address of the relay module to 'C2'. The 'MODE 2' LED flashes to indicate push button learning mode (PBM).

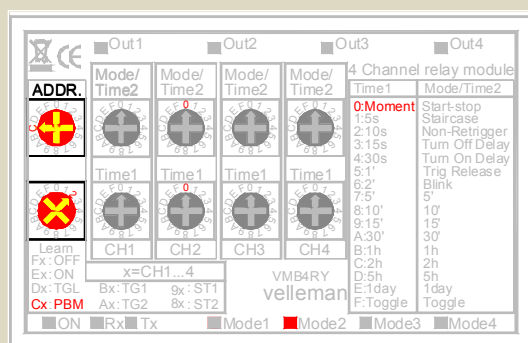

5. Press and hold the second push button (BOOST) of the temperature sensor until the relay is energised and the red LED on the sensor module flashes.

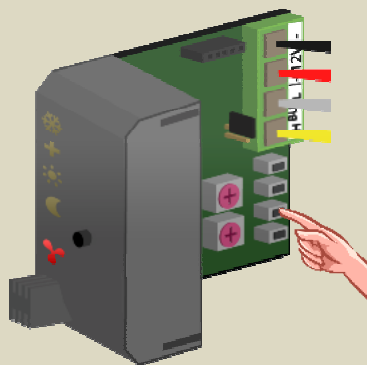

6. Set the address of the relay module back to its original value.

## Allocate a relay channel to set the boiler in day mode

Some heating boilers have a contact input to set them in day or night mode. In night mode, the boiler temperature is set approximately 10 degrees lower.

The heater boiler must be placed in day mode as soon as one of the sensor modules switches to day or comfort mode.

In this example, this is done using relay channel 3.

1. Set all sensor modules in anti-freeze mode by pressing the push button on the front panel repeatedly until all LEDs are off.

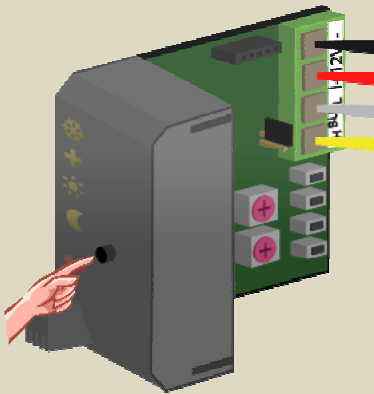

2. Set the MODE and TIME1 rotary switches for channel 3 of the relay module to '0' (instant control).
3. Remember the address of this relay module to reinstate it later on.
4. Set the address of the relay module to 'C3'. The 'MODE 3' LED flashes to indicate push button learning mode (PBM).

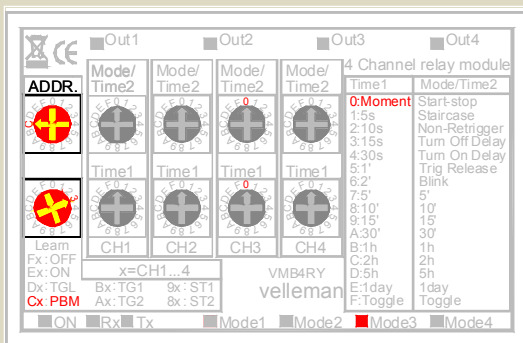

5. Press and hold the third push button (DAY) of the first temperature sensor until the relay is energised and the red LED on the sensor module flashes.

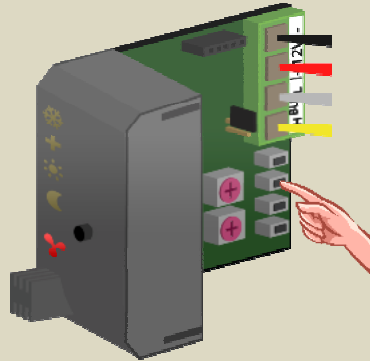

6. Press and hold the third push button (DAY) of the second temperature sensor until the relay is energised and the red LED on the sensor module flashes.

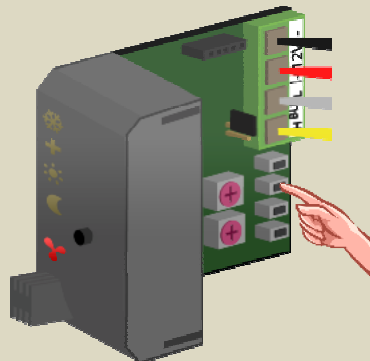

7. Repeat step 5 for all other sensors.

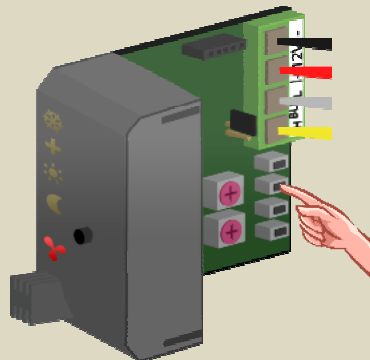

8. Set the address of the first relay module back to its original value.

## Allocate a relay channel to steer an air-conditioner

The temperature sensor can also be used to control an air-conditioning system. When the sensor is in cooling mode, the heating will be switched to anti-freeze mode.

When room temperature rises above the desired value, a relay must be energised to switch on the air-conditioner. When the temperature drops below the desired value the relay must be de-energised to stop cooling.

In this example relay channel 4 is used to steer the air-conditioner.

1. Set the sensor module in anti-freeze mode by pressing the push button on the front panel repeatedly until all LEDs are off.

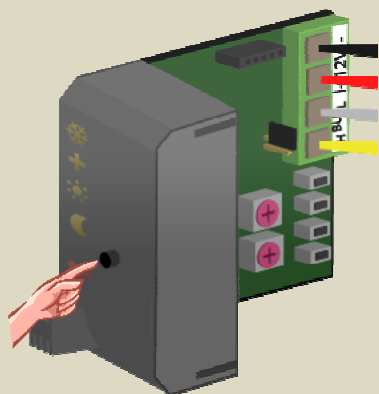

2. Set the MODE and TIME1 rotary switches for channel 4 of the relay module to '0' (instant control).
3. Remember the address of this relay module to reinstate it later on.
4. Set the address of the relay module to 'C4'. The 'MODE 4' LED flashes to indicate push button learning mode (PBM).

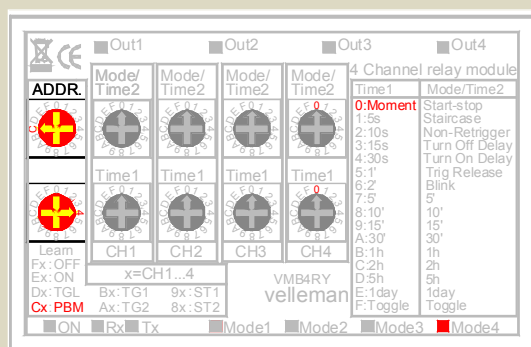

5. Press and hold the upper push button (COOL) of the temperature sensor until the relay is energised and the red LED on the sensor module flashes.

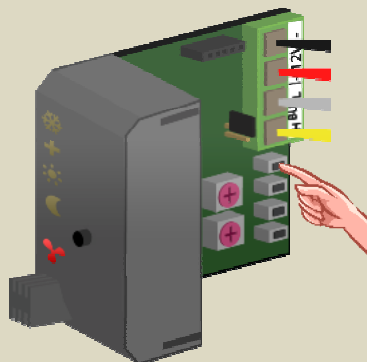

6. Set the address of the relay module back to its original value.
7. The sensor module must be placed in cooling mode via the temperature controller VMB1TC or through the Velbus link software. The upper LED (ice crystal) must be lit.



## Allocate a relay channel for the circulation pump

Some valves have a contact that closes when the valve is open. By wiring all the contacts in parallel, the circulation pump can be steered.

For valves that do not have these contacts, a relay can be assigned to the temperature sensors to steer the circulation pump.

In this example the pump must be active as soon as one of the sensor modules indicates heating is required. This can be done e.g. through relay channel 1 of a relay module.

1. Set all sensor modules in anti-freeze mode by pressing the push button on the front panel repeatedly until all LEDs are off.

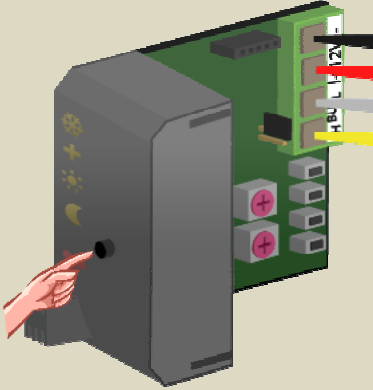

2. Set the MODE and TIME1 rotary switches for channel 1 of the relay module to '0' (instant control).
3. Remember the address of this relay module to reinstate it later on.
4. Set the address of the relay module to 'C1'. The 'MODE 1' LED flashes to indicate push button learning mode (PBM).

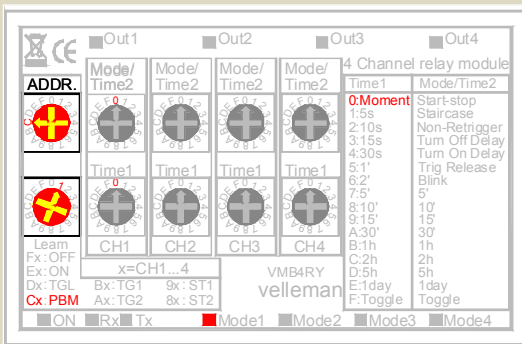

5. Press and hold the pushbutton on the front panel of the first sensor module and simultaneously press and hold the lowest push button (HEAT) until the relay is energised and the red LED on the sensor module flashes. First release the lowest push button (HEAT) followed by the push button on the front panel.

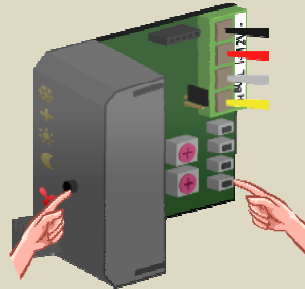

6. Press and hold the pushbutton on the front panel of the second sensor module and simultaneously press and hold the lowest push button (HEAT) until the relay is energised and the red LED on the sensor module flashes. First release the lowest push button (HEAT) followed by the push button on the front panel.

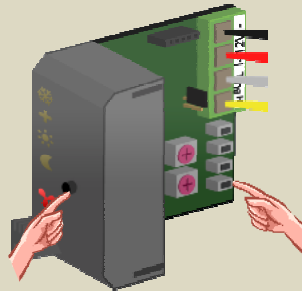

7. Repeat step 5 for all other sensors.

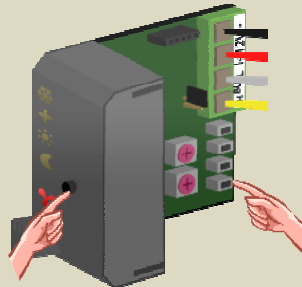

8. Set the address of the relay module back to its original value.

## Allocate a relay channel for the low temperature alarm

The sensor module contains an anti-freeze protection, but when the heating system is down it is still possible that the temperature in a room drops. To warn the user that the room temperature reaches freezing point a relay can be energised. This relay channel can be used e.g. to switch on a control light or an electrical heater.

As an example relay channel 2 of a relay module is used.

1. Set the sensor module in anti-freeze mode by pressing the push button on the front panel repeatedly until all LEDs are off.

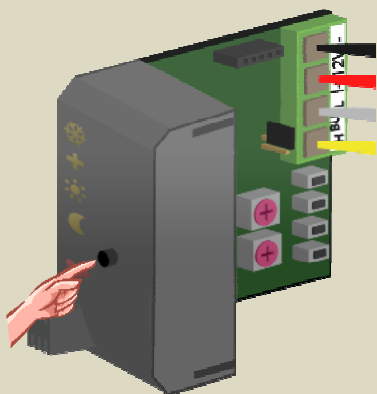

2. Set the MODE and TIME1 rotary switches for channel 2 of the relay module to '0' (instant control).
3. Remember the address of this relay module to reinstate it later on.
4. Set the address of the relay module to 'C2'. The 'MODE 2' LED flashes to indicate push button learning mode (PBM).

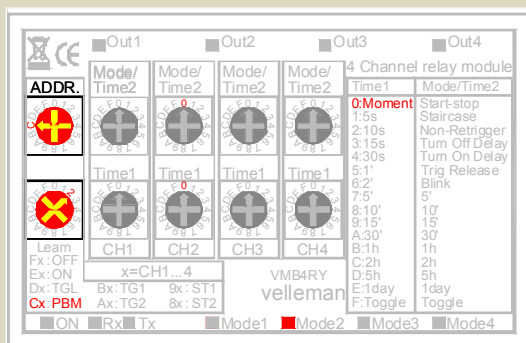

5. Press and hold the pushbutton on the front panel of the sensor module and simultaneously press and hold the second push button (BOOST) until the relay is energised and the red LED on the sensor module flashes. First release the second push button (BOOST) followed by the push button on the front panel.

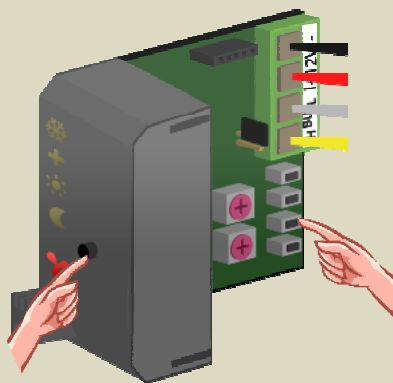

6. Set the address of the relay module back to its original value.



## Allocate a relay channel for the high temperature alarm

The sensor module can also control a relay when room temperature should reach extreme high values. This situation might occur when a heating valve is broken e.g. it does not close anymore causing the room to keep heating up. The relay contact can then be used e.g. to switch on a warning light or activate an audible warning signal.

As an example, relay channel 3 of a relay module is used.

1. Set the sensor module in anti-freeze mode by pressing the push button on the front panel repeatedly until all LEDs are off.

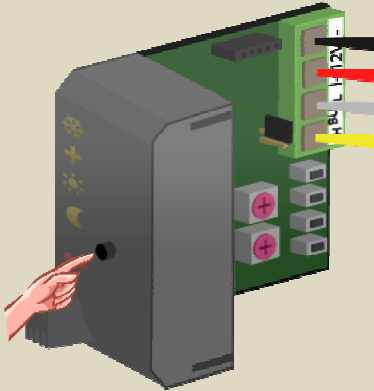

2. Set the MODE and TIME1 rotary switches for channel 3 of the relay module to '0' (instant control).
3. Remember the address of this relay module to reinstate it later on.
4. Set the address of the relay module to 'C3'. The 'MODE 3' LED flashes to indicate push button learning mode (PBM).

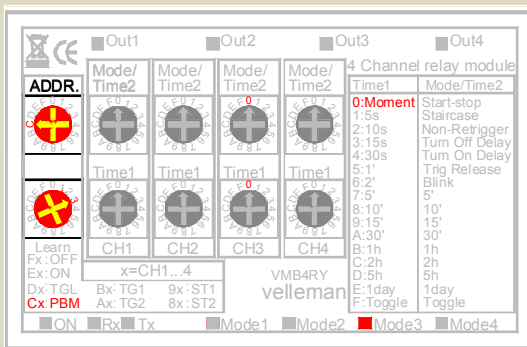

5. Press and hold the pushbutton on the front panel of the sensor module and simultaneously press and hold the third push button (DAY) until the relay is energised and the red LED on the sensor module flashes. First release the third push button (DAY) followed by the push button on the front panel.

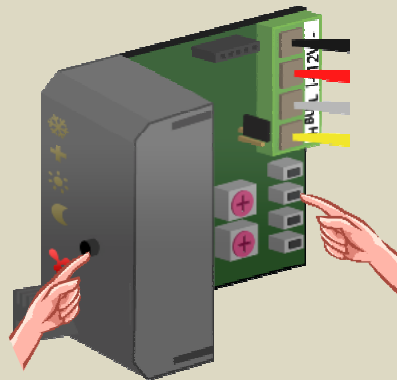

6. Set the address of the relay module back to its original value.

## REMOTE CONTROL

The sensor module can be operated locally, but also remotely via a temperature controller VMB1TC (refer to the manual of the controller).

The sensor module can also be operated remotely by connecting pushbuttons to the Velbus. Pushbuttons can be defined for:

- setting the sensor module mode to comfort
- setting the sensor module mode to day
- setting the sensor module mode to night
- setting the sensor module mode to anti-freeze
- setting the sensor module mode to heating
- setting the sensor module mode to cooling
- lock the local operation of the sensor module
- unlock the local operation of the sensor module







For every operating function up to 10 different pushbuttons can be assigned.

The easiest way to assign those pushbuttons is by using the Velbus link software using a PC that is connected to a Velbus PC interface (VMB1USB, VMB1RS or VMBRSUSB).

However, it can be done without using a PC.

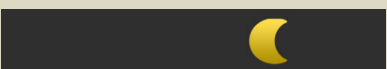
Always remember the address of the sensor module to reinstate it later on.

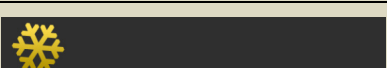
Set the address of the sensor module to the function for which pushbuttons will be assigned.

Address learning mode	Flashing indication LEDs	Function
F1		Pushbuttons that put the sensor module in comfort mode
E1		Pushbuttons that put the sensor module in day mode
D1		Pushbuttons that put the sensor module in night mode
C1		Pushbuttons that put the sensor module in anti-freeze mode
B1		Pushbuttons that put the sensor module in heating mode
A1		Pushbuttons that put the sensor module in cooling mode
91		Pushbuttons that lock the local operation of the sensor module
81		Pushbuttons that unlock the local operation of the sensor module

Adding a pushbutton is done by pressing on it until its indication LED flashes. If this fails, the maximum number of pushbuttons is reached.

When finished, reinstate the original address of the sensor module.

In the example below we use a control panel VMB4PD of which 8 controls are linked to a temperature sensor.

The labels on the display are assigned as indicated (refer to the manual of the VMB4PD):



The labels on the display for the second page are assigned as indicated:

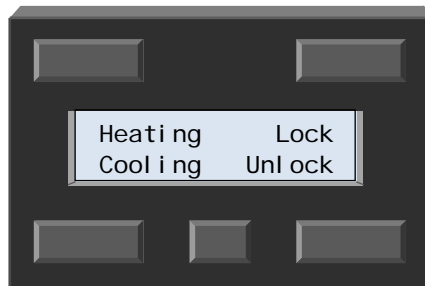

## Remotely control comfort mode

With the upper left button of the control panel the temperature sensor is set to comfort mode.

1. Remember the address of the sensor module to reinstate it later.
2. Set the address of the sensor module to 'F1'. The comfort and day LEDs are flashing to indicate learning mode for pushbuttons that place the module in comfort mode.

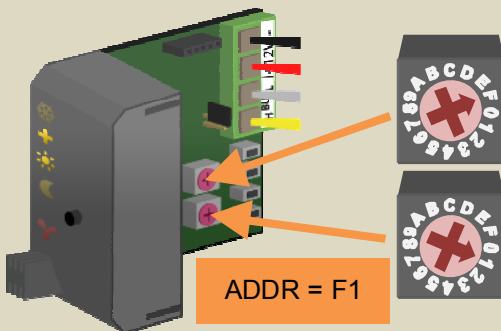

*Remark:*  
When multiple sensor modules need to react to the same pushbutton, remember their addresses and set them also to 'F1'.

3. Press and hold the 'Comfort' pushbutton (at least 1 second) until its indication LED starts flashing.



*Remark:*  
As long as the pushbutton is pressed, the LEDs on the sensor module will be off. This to confirm that the pushbutton is assigned.

4. Repeat step 3 in case other pushbuttons must set the sensor module in comfort mode.
5. Reinststate the address of the sensor module(s) to its (their) original value.

## Remotely control day mode

With the upper right button of the control panel the temperature sensor is set to day mode.

1. Remember the address of the sensor module to reinstate it later.
2. Set the address of the sensor module to 'E1'.  
The day LED is flashing to indicate learning mode for pushbuttons that place the module in day mode.

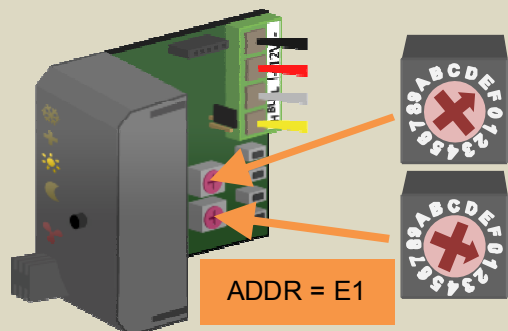

*Remark:*

When multiple sensor modules need to react to the same pushbutton, remember their addresses and set them also to 'E1'.

3. Press and hold the 'day' pushbutton (at least 1 second) until its indication LED starts flashing.



*Remark:*

As long as the pushbutton is pressed, the LEDs on the sensor module will be off. This to confirm that the pushbutton is assigned.

4. Repeat step 3 in case other pushbuttons must set the sensor module in day mode.
5. Reinststate the address of the sensor module(s) to its (their) original value.

## Remotely control night mode

With the lower left button of the control panel the temperature sensor is set to night mode.

1. Remember the address of the sensor module to reinstate it later.
2. Set the address of the sensor module to 'D1'. The night LED is flashing to indicate learning mode for pushbuttons that place the module in night mode.

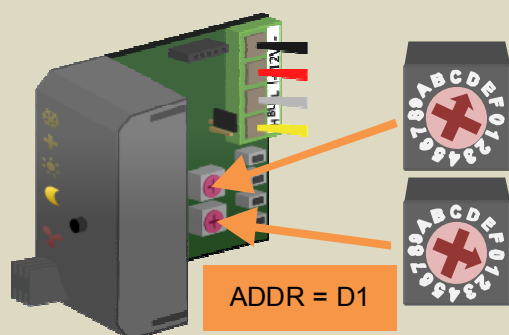

*Remark:*  
When multiple sensor modules need to react to the same pushbutton, remember their addresses and set them also to 'D1'.

3. Press and hold the 'night' pushbutton (at least 1 second) until its indication LED starts flashing.



*Remark:*  
As long as the pushbutton is pressed, the LEDs on the sensor module will be off. This is to confirm that the pushbutton is assigned.

4. Repeat step 3 in case other pushbuttons must set the sensor module in night mode.
5. Reinststate the address of the sensor module(s) to its (their) original value.

## Remotely control anti-freeze mode

With the lower right button of the control panel the temperature sensor is set to anti-freeze mode.

1. Remember the address of the sensor module to reinstate it later.
2. Set the address of the sensor module to 'C1'.  
The day, night and comfort LEDs are flashing to indicate learning mode for pushbuttons that place the module in anti-freeze mode.

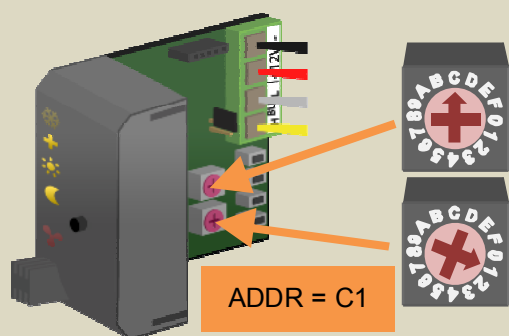

*Remark:*

When multiple sensor modules need to react to the same pushbutton, remember their addresses and set them also to 'C1'.

3. Press and hold the 'anti-freeze' pushbutton (at least 1 second) until its indication LED starts flashing.



*Remark:*

As long as the pushbutton is pressed, the LEDs on the sensor module will be off. This is to confirm that the pushbutton is assigned.

4. Repeat step 3 in case other pushbuttons must set the sensor module in anti-freeze mode.
5. Reinststate the address of the sensor module(s) to its (their) original value.

## Remotely set heating mode

With the upper left button on the second page of the control panel the temperature sensor is set in heating mode.

1. Remember the address of the sensor module to reinstate it later.
2. Set the address of the sensor module to 'B1'. The heating LED flashes to indicate learning mode for pushbuttons that place the module in heating mode.

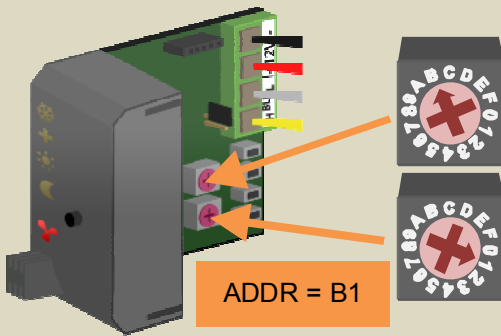

*Remark:*

When multiple sensor modules need to react to the same pushbutton, remember their addresses and set them also to 'B1'.

3. Select the second page of the control panel by pressing the small pushbutton.

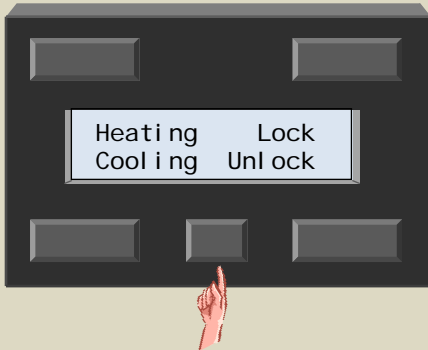

4. Press and hold the 'Heating' pushbutton (at least 1 second) until its indication LED starts flashing.

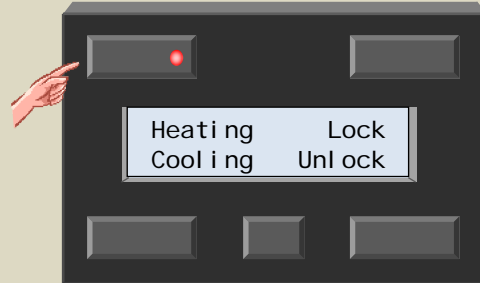

*Remark:*

As long as the pushbutton is pressed, the LEDs on the sensor module will be off. This to confirm that the pushbutton is assigned.

5. Repeat step 4 in case other pushbuttons must set the sensor module in heating mode.
6. Reinstate the address of the sensor module(s) to its (their) original value.

## Remotely set cooling mode

With the lower left button on the second page of the control panel the temperature sensor is set in cooling mode.

1. Remember the address of the sensor module to reinstate it later.
2. Set the address of the sensor module to 'A1'. The cooling mode LED flashes to indicate learning mode for pushbuttons that place the module in cooling mode.

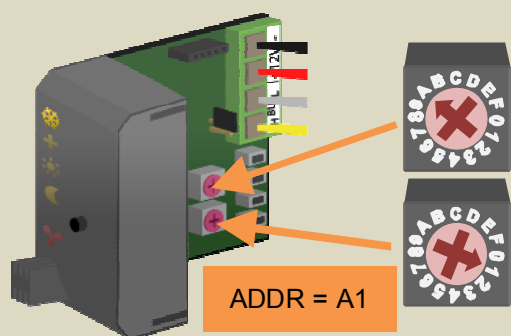

*Remark:*

When multiple sensor modules need to react to the same pushbutton, remember their addresses and set them also to 'A1'.

3. Select the second page of the control panel by pressing the small pushbutton.

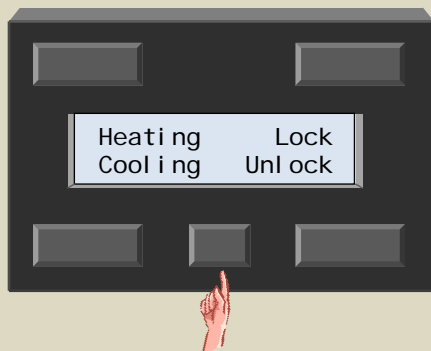

4. Press and hold the 'Cooling' pushbutton (at least 1 second) until its indication LED starts flashing.

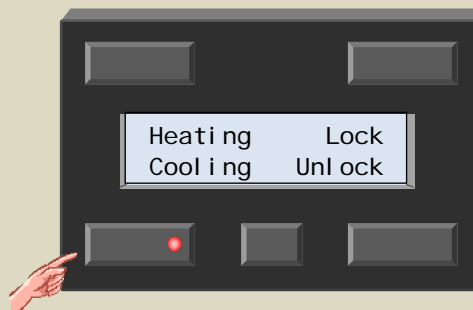

*Remark:*

As long as the pushbutton is pressed, the LEDs on the sensor module will be off. This is to confirm that the pushbutton is assigned.

5. Repeat step 4 in case other pushbuttons must set the sensor module in cooling mode.
6. Reinstate the address of the sensor module(s) to its (their) original value.



## Remotely lock local operation

With the upper right button on the second page of the control panel locally operating the temperature sensor can be disabled.

1. Remember the address of the sensor module to reinstate it later.
2. Set the address of the sensor module to '91'. All LEDs are flashing to indicate learning mode for pushbuttons that lock local operation.

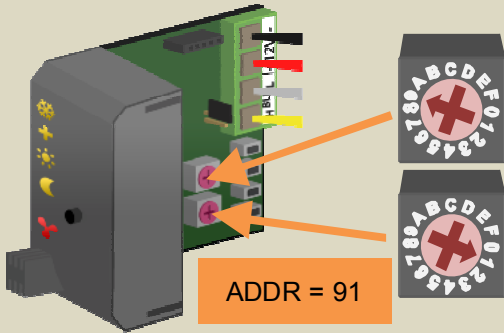

*Remark:*

When multiple sensor modules need to react to the same pushbutton, remember their addresses and set them also to '91'.

3. Select the second page of the control panel by pressing the small pushbutton.

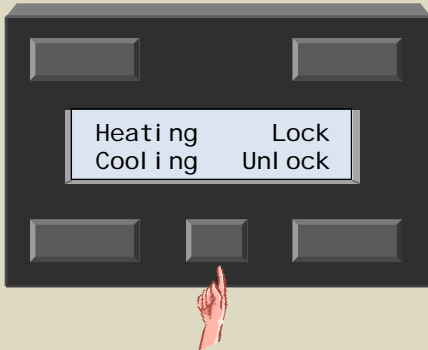

4. Press and hold the 'Lock' pushbutton (at least 1 second) until its indication LED starts flashing.



*Remark:*

As long as the pushbutton is pressed, the LEDs on the sensor module will be off. This to confirm that the pushbutton is assigned.

5. Repeat step 4 in case other pushbuttons must disable local operation of the sensor.
6. Reinstate the address of the sensor module(s) to its (their) original value.

## Remotely unlock local operation

With the lower right button on the second page of the control panel locally operating the temperature sensor can be enabled.

1. Remember the address of the sensor module to reinstate it later.
2. Set the address of the sensor module to '81'. The cooling, comfort, day and night LEDs are flashing to indicate learning mode for pushbuttons that unlock local operation.

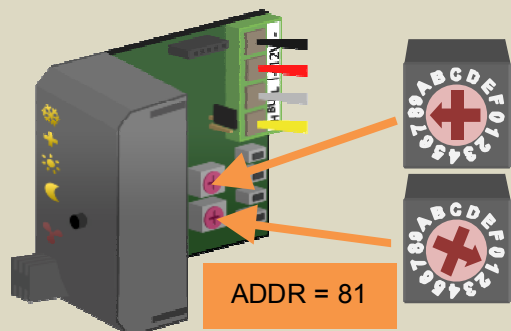

*Remark:*

When multiple sensor modules need to react to the same pushbutton, remember their addresses and set them also to '81'.

3. Select the second page of the control panel by pressing the small pushbutton.

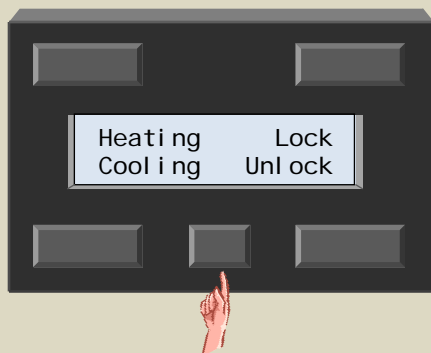

4. Press and hold the 'Unlock' pushbutton (at least 1 second) until its indication LED starts flashing.



*Remark:*







As long as the pushbutton is pressed, the LEDs on the sensor module will be off. This to confirm that the pushbutton is assigned.

5. Repeat step 4 in case other pushbuttons must enable local operation of the sensor.
6. Reinstate the address of the sensor module(s) to its (their) original value.

## Deleting an assigned pushbutton

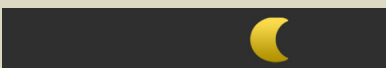
Always remember the address of the sensor module to reinstate it later on.

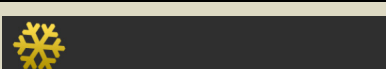
Set the address of the sensor module to the function for which pushbuttons must be deleted.

Address learning mode	Flashing indication LEDs	Function
F1		Pushbuttons that put the sensor module in comfort mode
E1		Pushbuttons that put the sensor module in day mode
D1		Pushbuttons that put the sensor module in night mode
C1		Pushbuttons that put the sensor module in anti-freeze mode
B1		Pushbuttons that put the sensor module in heating mode
A1		Pushbuttons that put the sensor module in cooling mode
91		Pushbuttons that lock the local operation of the sensor module
81		Pushbuttons that unlock the local operation of the sensor module

The indication LEDs of the pushbuttons that are assigned to the selected function will flash.







Deleting an assigned pushbutton is done by pressing it until its indication LED switches off.

When finished, reinstate the original address of the sensor module.

## Deleting all assigned pushbuttons for a certain function

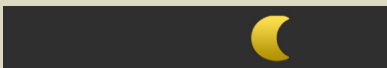
Always remember the address of the sensor module to reinstate it later on.

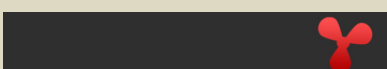
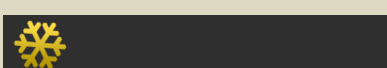
Set the address of the sensor module to the function for which pushbuttons must be deleted.

Address learning mode	Flashing indication LEDs	Function
F1		Pushbuttons that put the sensor module in comfort mode
E1		Pushbuttons that put the sensor module in day mode
D1		Pushbuttons that put the sensor module in night mode
C1		Pushbuttons that put the sensor module in anti-freeze mode
B1		Pushbuttons that put the sensor module in heating mode
A1		Pushbuttons that put the sensor module in cooling mode
91		Pushbuttons that lock the local operation of the sensor module
81		Pushbuttons that unlock the local operation of the sensor module

The indication LEDs of the pushbuttons that are assigned to the selected function will flash.

Deleting all pushbutton assigned to the selected function is done by pressing the pushbutton on the front panel of the sensor module until all LEDs are off.

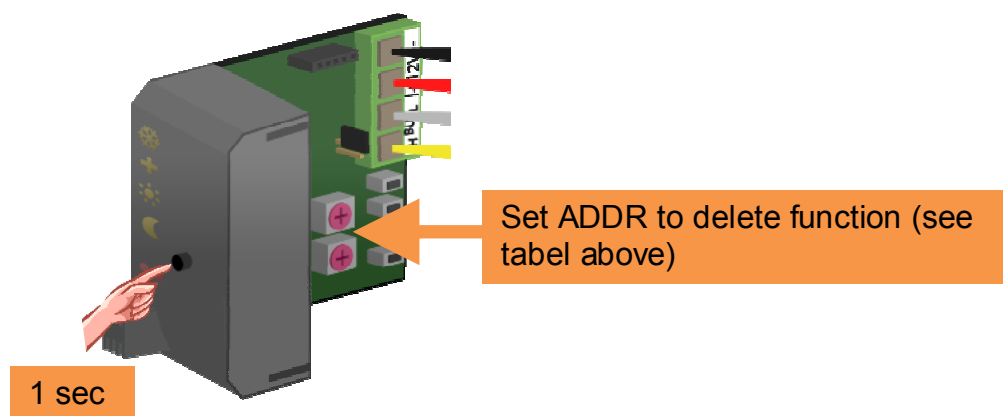

When releasing the pushbutton the indication LEDs of all the assigned pushbuttons will turn off and the LEDs on the sensor module start flashing.

When finished, reinstate the original address of the sensor module.

## Deleting all assigned pushbuttons

Always remember the address of the sensor module to reinstate it later on.

Set the address of the sensor module to 'F1'. the comfort and day LED are flashing.

Deleting all assigned pushbuttons for all functions at once is done by pressing the mode pushbutton on the sensor module for about 10 seconds.

The indication LEDs on the sensor module will first switch off and about 7 seconds later will start flashing to confirm the deleting operation.

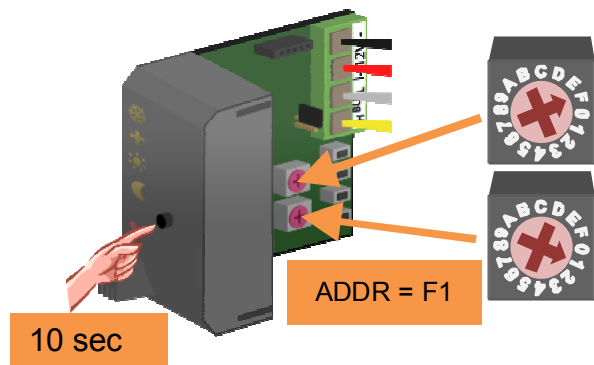

When finished, reinstate the original address of the sensor module.

## SWITCHING TO ANTI FREEZE MODE THROUGH WINDOW CONTACTS

The heating can be switched automatically in anti freeze mode as soon as a window featuring window contacts is opened.

The LEDs will switch off on the VMB1TS temperature sensor. The VMB1TC temperature controller displays an anti freeze and key symbol together with a blinking mode LED.



The heating cannot be set into another mode as long as a window remains open.

Once all windows closed, the heating will switch to the initial mode.

The used contacts may be of the NO or the NC type, and may be connected to a VMB8PB push-button interface or a VMB6IN input module.

You can connect maximum 10 NO and 10 NC contacts to the sensor module.

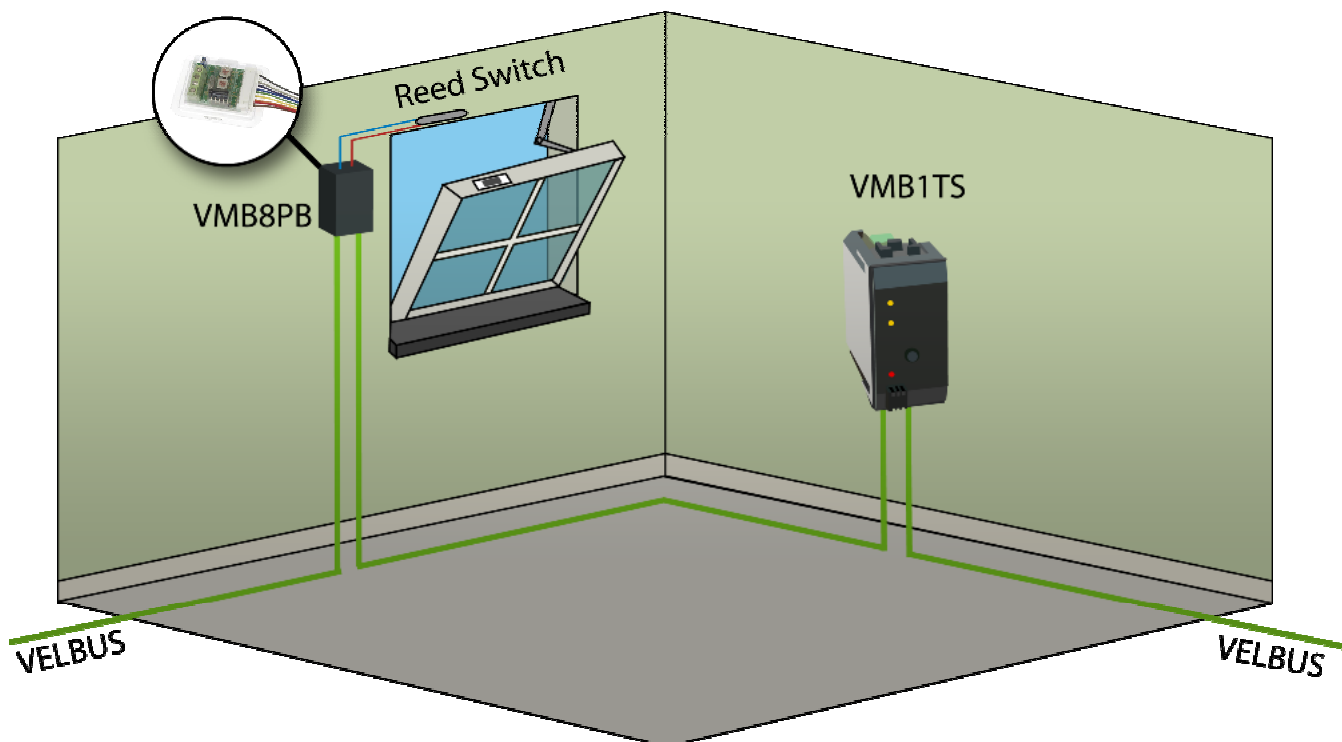

Assign the contacts through Velbuslink software and a PC connected the Velbus interface (VMB1USB, VMB1RS or VMBRSUSB).

The NC contacts (i.e. contacts closed when window is closed) must be connected to the “Normal closed disable switch” function of the sensor module.

The NO contacts (i.e. contacts open when the window is closed) must be connected to the “Normal open disable switch” function of the sensor module.

Remark:

This function is only available on a sensor module with software version 0949 or higher (see “Verify software version” in this user manual).

## DIFFERENTIAL THERMOSTAT

Using two sensors, a differential thermostat can be created. When the temperature difference between both sensors crosses a preset value, a relay channel can be activated.

To achieve this, the first sensors must know the address of the second one. The second sensor must than be linked to a relay channel. The temperature difference value is set on the first sensor.

The settings can be done via a temperature controller VMB1TC or via the Velbus link program.

Schematic overview differential thermostat (sensor2 in heating mode):

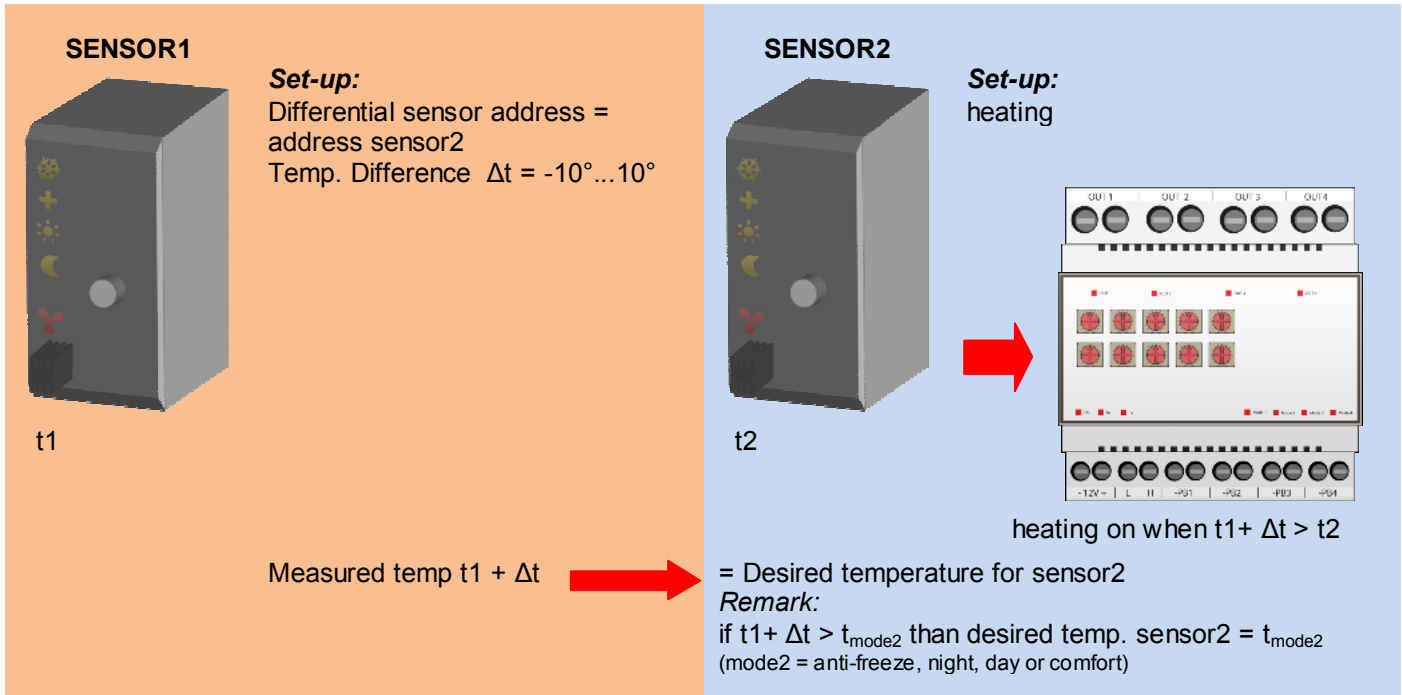

Schematic overview differential thermostat (sensor2 in cooling mode):

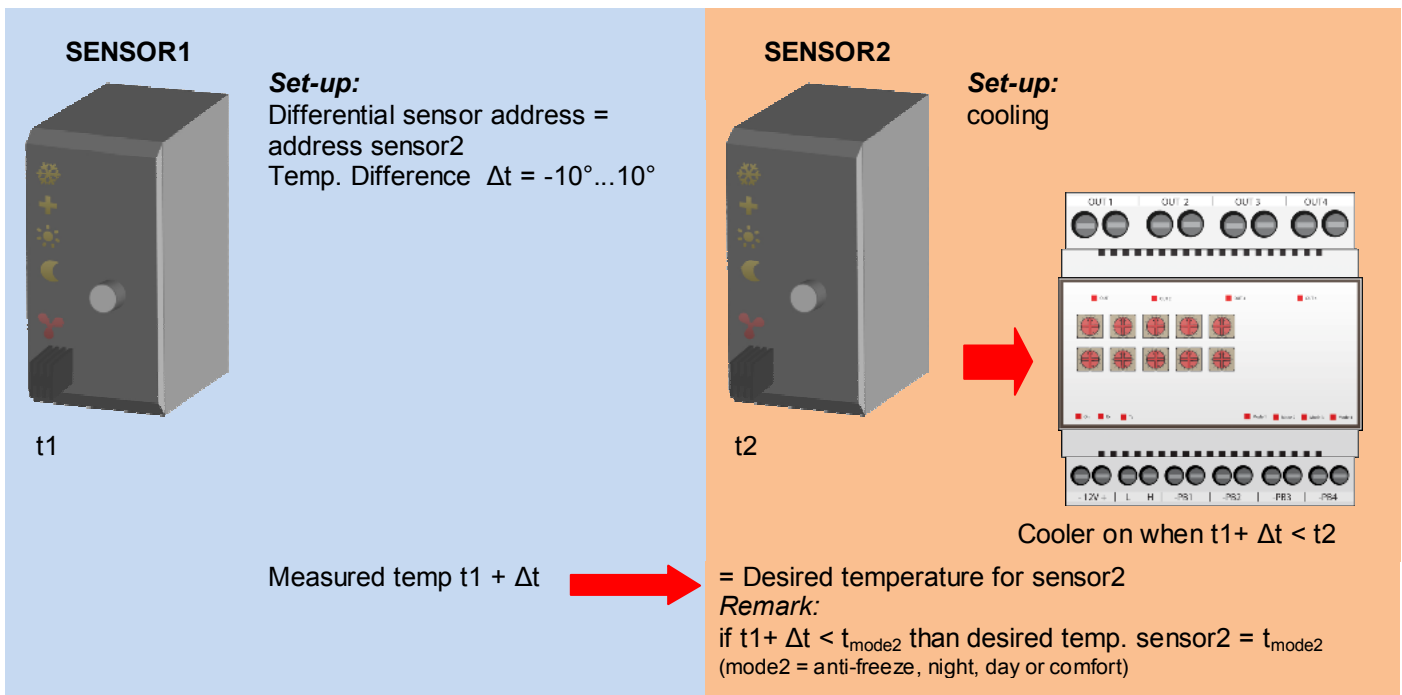

Refer to some applications of a differential thermostat below.

## The passage automatically 3° cooler than the office

When the sensor module in the office is set to day-mode, the temperature in the passage must be 3° lower than the office. Is the day temperature of the office is set to 20°C the desired passage temperature will be 17°C.  
When the sensor module in the office is set to night-mode, the temperature in the passage must be 3° lower than the office. Is the night temperature of the office is set to 15°C the desired passage temperature will be 12°C.

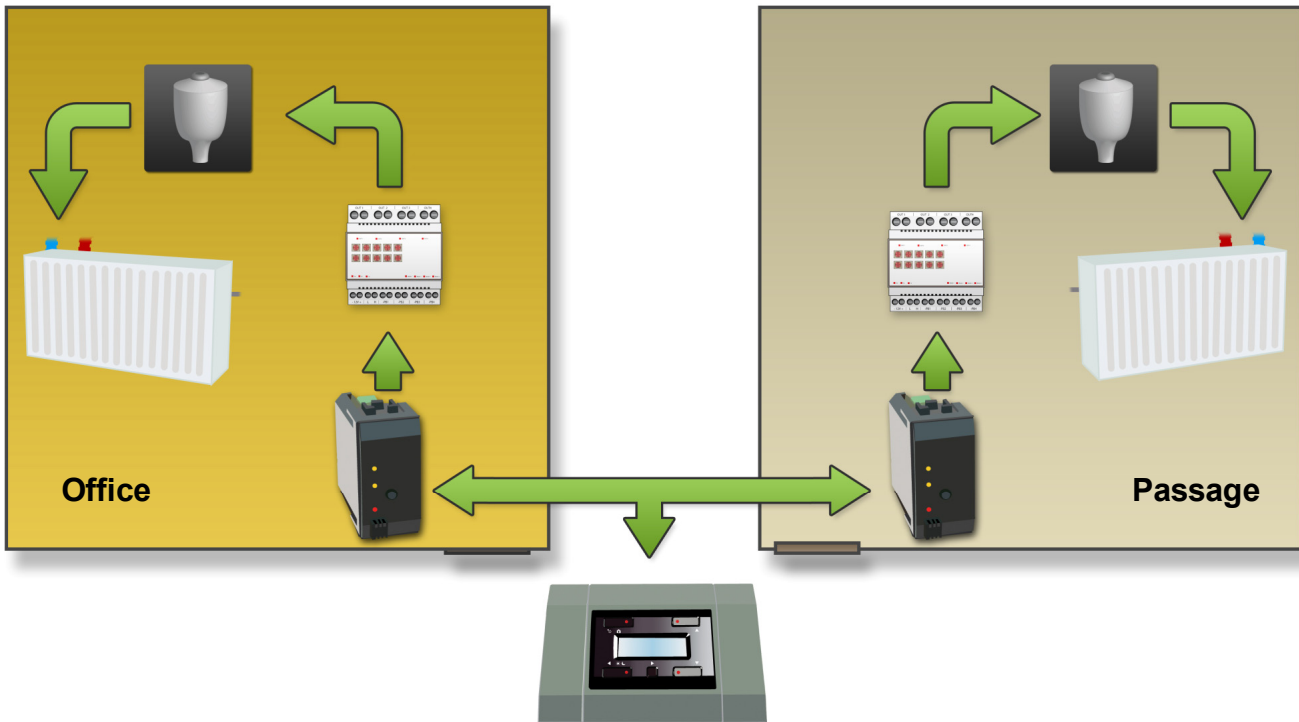

### Configuration:

The easiest way to configure the system is to use the Velbus link program via a PC connected on the Velbus PC interface (VMB1USB, VMB1RS or VMBRSUSB).

However, configuration can also be done without the aid of a computer. Refer to the procedure below.

1. Link the heating output of the office sensor to a relay channel.
2. Use the relay channel to control the valve of the office radiator.
3. Link the heating output of the passage sensor to another relay channel.
4. Use this relay channel to control the valve of the passage radiator
5. On the temperature controller, select the office sensor.
6. Go to the extended menu.
7. Scroll to the sensor setup menu and select it.
8. Scroll to the 'diff. sensor' submenu and select it.
9. Choose the passage sensor and confirm.
10. Scroll to the 'Temp. diff.' submenu and select it.
11. Set the temperature difference to -3° and confirm.
12. Quit the menu.

The configuration is now finished and the differential thermostat is enabled.

### Remarks:

- Make sure both sensors are in heating mode (frost flower LED on the sensor is off).
- The passage temperature can never be higher than the preferred setting of its selected mode (anti-freeze, night, day or comfort).



## Passive cooling of a bedroom

During summer time the bedroom is cooled via a fan that extracts air from a cooler room.

Mount a temperature sensor in both rooms. The temperature sensor of the bedroom is set to cooling mode and the cooling output is linked to a relay channel that controls the fan.

When the temperature in the cooler room is about 3 degrees lower than the bedroom temperature the fan is activated.

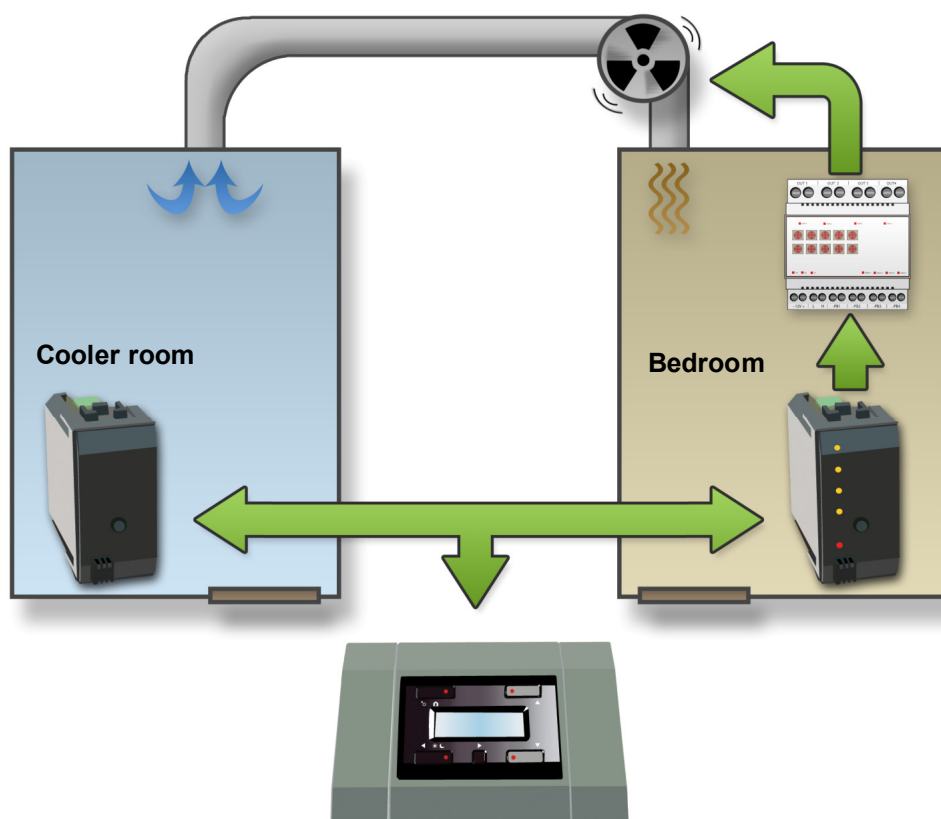

### Configuration:

The easiest way to configure the system is to use the Velbus link program via a PC connected on the Velbus PC interface (VMB1USB, VMB1RS or VMBRSUSB).

However, configuration can also be done without the aid of a computer. Refer to the procedure below.

1. Link the cooling output of the bedroom sensor to a relay channel.
2. Use the relay channel to control the fan.
3. On the temperature controller, select the sensor of the coolest room.
4. Go to the extended menu.
5. Scroll to the sensor setup menu and select it.
6. Scroll to the 'diff. sensor' submenu and select it.
7. Choose the bedroom sensor and confirm.
8. Scroll to the 'Temp. diff.' submenu and select it.
9. Set the temperature difference to 3° and confirm.
10. Quit the menu.
11. Select the bedroom sensor on the temperature controller
12. Go to the extended menu.
13. Scroll to the sensor setup menu and select it.
14. Select the operating mode submenu.
15. Set it to cooling and confirm.
16. Quit the menu.

The configuration is now finished and the differential thermostat is enabled.

### Remark:

The cooling will stop when the bedroom temperature reaches the preferred setting of its selected mode (anti-freeze, night, day or comfort).

## VERIFY SOFTWARE VERSION

The software version can be verified via the Velbus link software.

Check on <http://www.velbus.eu> whether you have the latest version. If a newer version is available, download it. Connect the Velbus interface to a PC and run the upgrade-software and follow the instructions on the screen.

**Remark:**

Upgrading a module is not without risk. **Do not** interrupt the process!

If for any reason the upgrade should fail, the module will cease normal operation. The module will have to be returned to the manufacturer.

en :: fr :: nl ::



by **velleman**

What is velbus? | Products | Virtual demo | Downloads | Pricelist | Newsletter | Links | Professional | Velleman.eu



**All appliances get intelligent, how about your home?**

Choosing for Velbus means choosing for a future-proof system which provides comfort, safety and a better energy management at a price which is just slightly higher than classical wiring.

**COMFORT**



Imagine coming home from a long day at work. With a single button press you turn on the heating, the blinds close, several lights turn on and create a cosy, intimate atmosphere. The wall outlets, which were shut off for safety reasons during your absence, are switched on again...

**SAFETY**



A sudden noise wakes you up in the middle of the night. Press your bedside button and your home comes alive. All lighting is turned on, while all blinds open. The garden lighting starts to flash, to attract attention...

**ENERGYSAVING**



Bedtime. Again, you press a single button. All lighting is turned off and nightlights start to glow. The garden remains lit for an hour. Wall outlets are turned off again for safety and to reduce electrosmog. Finally, the heating is lowered with a couple of degrees.

▶ Velbusmodules on Velleman website    ▶ Velleman Forum

**Refer to our website for more information: [www.velbus.be](http://www.velbus.be)**

